

Ecophon Master™ A

Ecophon Master™ A has an exposed grid system. Each tile is easily demountable. Suitable for open plan offices or other premises where strict demands are made on good acoustics and speech intelligibility, and where demountability is vital.



Castellum HQ, Sweden

SYSTEM RANGE

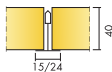

Size, mm	600x600	1200x600	1200x1200
Connect T15	•	•	•
Connect T24	•	•	•
Thickness (THK)	40	40	40
Inst. Diagr.	M56	M56	M56

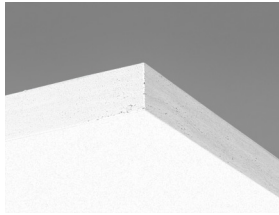

Master A tile

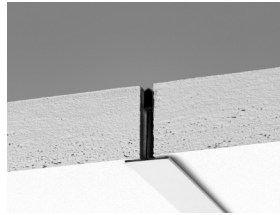

Section of Master A system

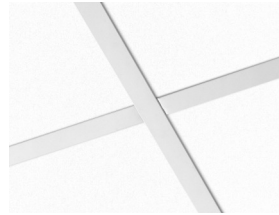

Master A system

Acoustic



Sound Absorption:

Test results according to EN ISO 354. Classification according to EN ISO 11654, and the single value ratings for Noise Reduction Coefficient, NRC and Sound Absorption Average, SAA according to ASTM C 423.

α_p , Practical sound absorption coefficient

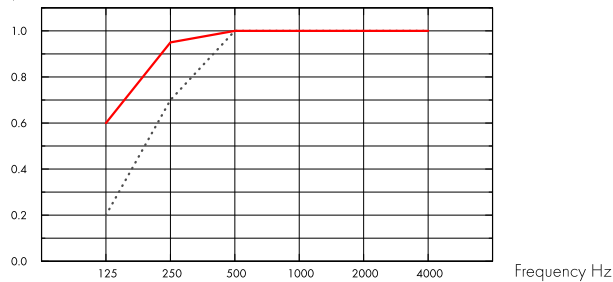

--- Master A 40 mm, 50 mm o.d.s.

— Master A 40 mm, 200 mm o.d.s.

o.d.s = overall depth of system

THK mm	o.d.s. mm	α_p , Practical sound absorption coefficient						α_w	Sound absorption class
		125 Hz	250 Hz	500 Hz	1000 Hz	2000 Hz	4000 Hz		
40	50	0.20	0.70	1.00	1.00	1.00	1.00	1.00	A
40	200	0.60	0.95	1.00	1.00	1.00	1.00	1.00	A

THK mm	o.d.s. mm	NRC	SAA
40	50	1.00	1.00
40	400	0.95	0.93

THK mm	AC(1.5)	D_{nfw}	CAC dB
	Articulation Class, ASTM E1111, ASTM E1110	Weighted normalized flanking level difference, ISO 10848-2	Ceiling Attenuation Class, ASTM 1414, ASTM E413
40	200	28	30

Indoor Air Quality



Certificate / Label	Plant	
Eurofins Indoor Air Comfort®	IAC	IAC Gold
French VOC	A	A+
Finnish M1	•	•



Environmental Footprint



	kg CO ₂ equiv/m ²
Master A	3,70
Master A/Plant	3,09

Life-cycle stages A1 to C4 from EPD, in conformity with ISO 14025 / EN 15804



Circularity

Minimum post-consumer recycled content	59%
Recyclability	Fully recyclable



Fire safety

Country	Class	
Europe	EN 13501-1	A2-s1,d0

The glass wool core of the tiles is tested and classified as non-combustible according to EN ISO 1182.



Humidity Resistance

Product	
Standard	Class C, RH 95% and 30°C
Plant	Class A, RH 70% and 25°C

According to EN 13964:2014



Visual appearance

White Frost, nearest NCS colour sample S 0500-N, 85% light reflectance. Gloss < 1.



Cleanability

Daily dusting and vacuum cleaning. Weekly wet wiping.



Accessibility

The tiles are easily demountable. Minimum demounting depth according to installation diagrams.



Installation

Installed according to installation diagrams, installation guides and drawing aid. For information regarding minimum overall depth of system see quantity specification.



System weight

The weight of the system (including suspension grid) should be approximately 5 kg/m².



Mechanical properties

See table about Max live load and Min load bearing capacity and Functional demands, Mechanical properties at www.ecophon.com.



CE

Ecophon ceiling systems are CE marked according to the European harmonized standard EN 13964:2014. CE marked construction products are covered by a Declaration of Performance (DOP) which enables customers and users to easily compare performance of products available on the European market.

INSTALLATION DIAGRAM (M56) FOR ECOPHON MASTER A

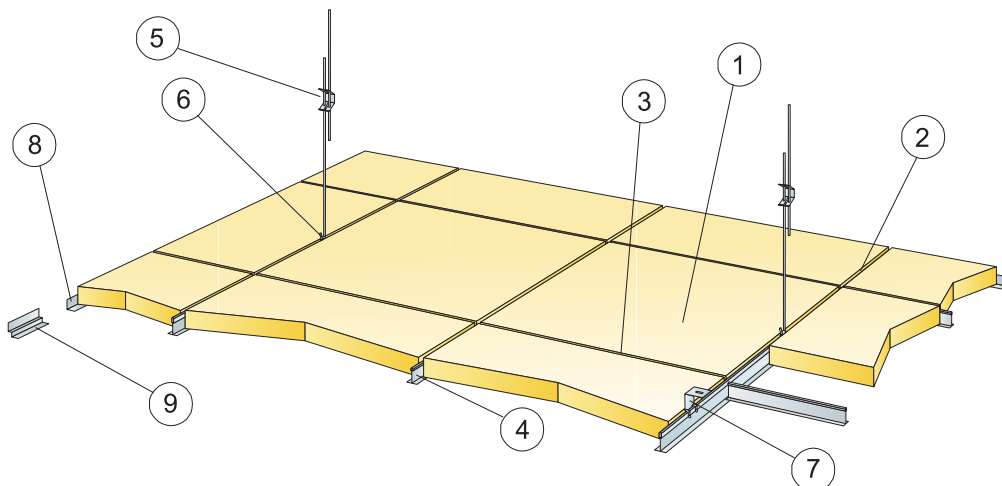

© Ecophon Group

QUANTITY SPECIFICATION (EXCL. WASTAGE)

	Size, mm		
	600x600	1200x600	1200x1200
1 Master A	2,8/m ²	1,4/m ²	0,7/m ²
2 Connect T24 Main runner, installed at 1200 mm centres (max. distance from wall 600 mm, can be extended up to 1200 mm if no live load between Main runner and wall).	0,9m/m ²	0,9m/m ²	0,9m/m ²
3 Connect T24 Cross tee, L=1200 mm, installed at 600 mm centres	1,7m/m ²	1,7m/m ²	0,9m/m ²
4 Connect T24 Cross tee, L=600 mm	0,9m/m ²	-	-
5 Connect Adjustable Hanger, installed at 1200 mm centres (max. distance from wall 600 mm)	0,7/m ²	0,7/m ²	0,7/m ²
6 Connect Hanger Clip (not to be used in swimming hall environments)	0,7/m ²	0,7/m ²	0,7/m ²
7 For direct installation: Connect Direct Bracket, installed at 1200 mm centres	0,7/m ²	0,7/m ²	0,7/m ²
8 Connect Angle trim, fixed at 300 mm centres	as required	as required	as required
9 Connect Shadow-line trim, fixed at 300 mm centres	as required	as required	as required
Δ Min. overall depth of system, with adjustable hanger: 100 mm, with direct bracket: 50 mm	-	-	-
δ Min. demounting depth: 170 mm, 200 mm with 1200x1200 mm	-	-	-

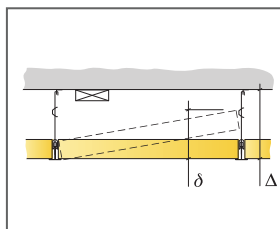

See Quantity specification

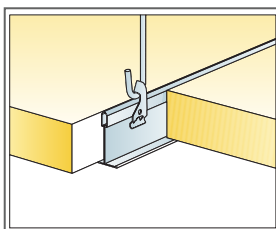

Suspension with adjustable hanger and clip

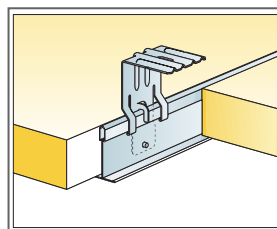

Suspension with direct bracket

Size, mm	Max live load (N)	Min load bearing capacity (N)
600x600x40	40	160
1200x600x40	40	160
1200x1200x40	40	160

Live load/load bearing capacity

Ecophon Master™ B

Ecophon Master™ B tiles are bonded edge-to-edge directly to the soffit surface, creating a ceiling with a smooth appearance. The bevelled edge creates a narrow groove between each tile. For applications where the minimum possible overall depth of system is required.



Kinderogesheim St. Markus, Germany

SYSTEM RANGE

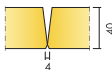

Size, mm	600x600	1200x600
Direct	•	•
Thickness (THK)	40	40
Inst. Diag.	M113	M113

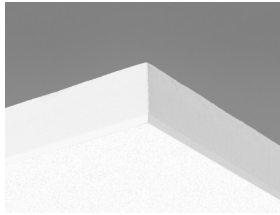

Master B tile

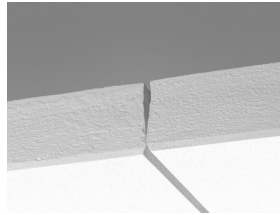

Section of Master B system

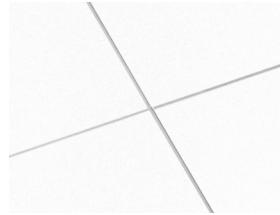

Master B system

Acoustic



Sound Absorption:

Test results according to EN ISO 354. Classification according to EN ISO 11654, and the single value ratings for Noise Reduction Coefficient, NRC and Sound Absorption Average, SAA according to ASTM C 423.

α_p , Practical sound absorption coefficient

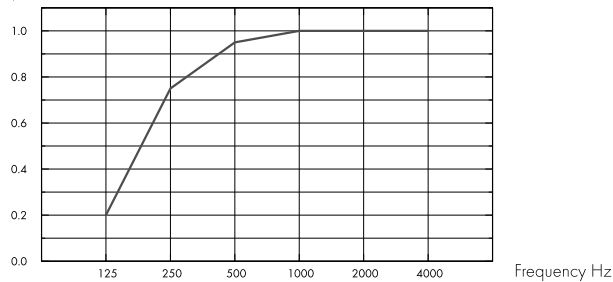

– Master B 40 mm, 43 mm o.d.s.
o.d.s = overall depth of system

THK mm	o.d.s. mm	α_p , Practical sound absorption coefficient						α_w	Sound absorption class
		125 Hz	250 Hz	500 Hz	1000 Hz	2000 Hz	4000 Hz		
40	43	0.20	0.75	0.95	1.00	1.00	1.00	1.00	A

THK mm	o.d.s. mm	NRC	SAA
40	43	0.95	0.93

Indoor Air Quality



Certificate / Label	
Eurofins Indoor Air Comfort®	IAC
French VOC	A
Finnish M1	•



Environmental Footprint



	kg CO ₂ equiv/m ²
Master B	7,30

Life-cycle stages A1 to C4 from EPD, in conformity with ISO 14025 / EN 15804

Circularity



Minimum post-consumer recycled content	62%
Recyclability	Fully recyclable

Fire safety



Country	Class
Europe	EN 13501-1 A2-s1,d0

The glass wool core of the tiles is tested and classified as non-combustible according to EN ISO 1182.



Humidity Resistance

Class C, relative humidity 95% and 30°C, according to EN 13964:2014



Visual appearance

White Frost, nearest NCS colour sample S 0500-N, 85% light reflectance. Gloss < 1.



Cleanability

Daily dusting and vacuum cleaning. Weekly wet wiping.



Accessibility

The tiles are not demountable.



Installation

Installed according to installation diagrams, installation guides and drawing aid. For information regarding minimum overall depth of system see quantity specification. Rendered surfaces must have sufficient strength to be able to carry the load imposed by the tiles. If doubts, test gluing should be carried out. The surface should always be dry and clean. For best result the surface should be even.



System weight

The weight of the system should be approximately 5 kg/m².



Mechanical properties

Additional live load has to be fixed to the soffit.



CE

Ecophon ceiling systems are CE marked according to the European harmonized standard EN 13964:2014. CE marked construction products are covered by a Declaration of Performance (DOP) which enables customers and users to easily compare performance of products available on the European market.

INSTALLATION DIAGRAM (M113) FOR ECOPHON MASTER B, USING CONNECT ABSORBER GLUE

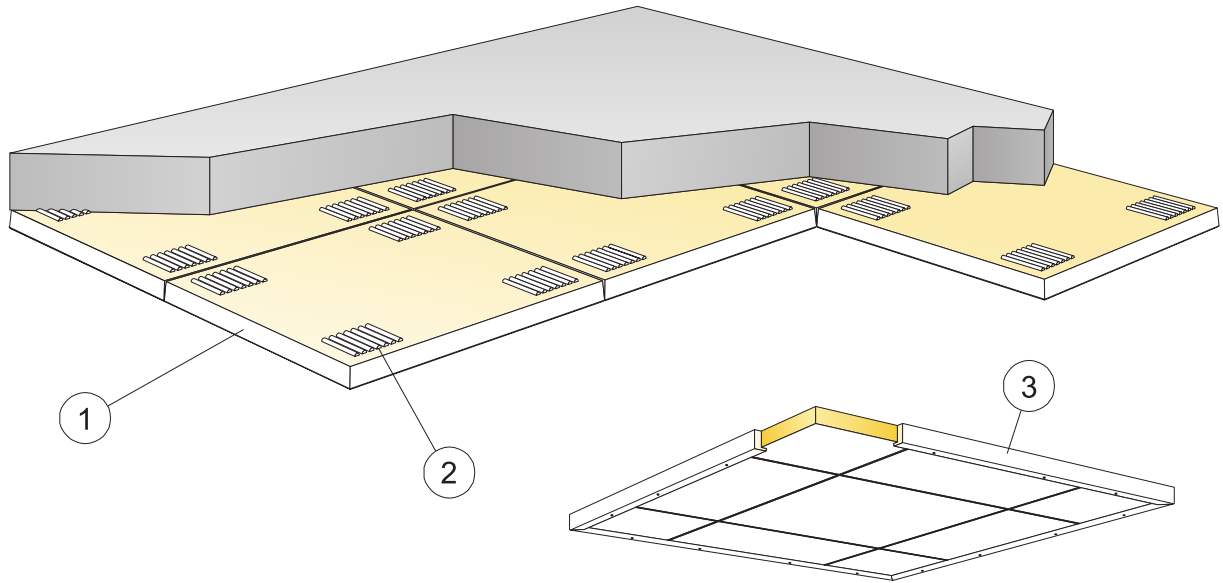

© Ecophon Group

QUANTITY SPECIFICATION (EXCL. WASTAGE)

	Size, mm	
	600x600	1200x600
1 Master B	2,8/m ²	1,4/m ²
2 Connect Absorber glue [0,25 l/m ² - 0,4 l/m ² depending on installation conditions]	as required	as required
Use Connect Notched spatula to apply the glue.	-	-
3 When installing floating ceilings: Connect Wood trim, L=3000, fixed at 500 mm centres	as required	as required
Δ Min. overall depth of system: 43 mm	-	-
δ Min. demounting depth: The system is not demountable	-	-
Visible edges should be painted	-	-

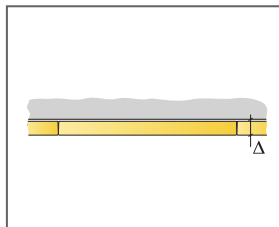

See Quantity specification

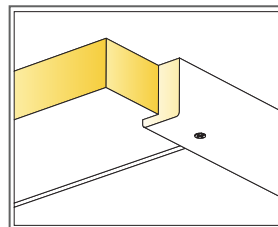

Wood trim for floating installation

Size, mm	Max live load (N)	Min load bearing capacity (N)
600x600x40	-	-
1200x600x40	-	-

Live load/load bearing capacity

Ecophon Master™ Ds

Ecophon Master™ Ds has a concealed grid and symmetrical edge design, allowing for easy assembly, and integration of light fittings and ventilation. For applications where a suspended ceiling with a concealed grid is required, but individual tiles must be easily demountable.



Hoaga-Hella Campus, Germany

SYSTEM RANGE

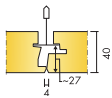

Size, mm	600x600
T24	•
Thickness (THK)	40
Inst. Diag.	M236, M242

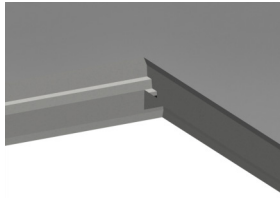

Master Ds tile

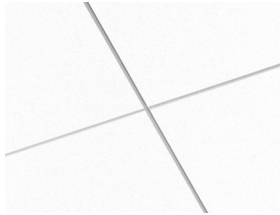

Master Ds system

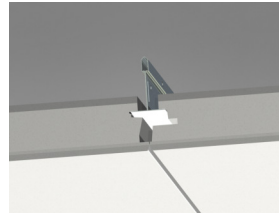

Section of Master Ds system.

Acoustic



Sound Absorption:

Test results according to EN ISO 354. Classification according to EN ISO 11654, and the single value ratings for Noise Reduction Coefficient, NRC and Sound Absorption Average, SAA according to ASTM C 423.

α_p , Practical sound absorption coefficient

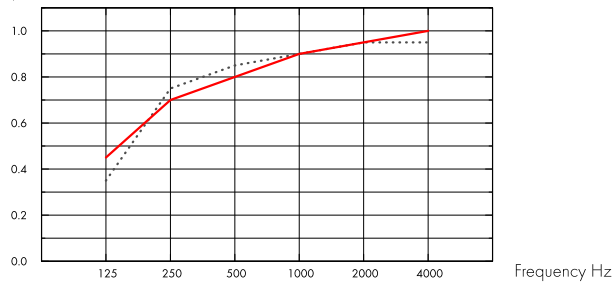

..... Master Ds 40 mm, 95 mm o.d.s.
 — Master Ds 40 mm, 200 mm o.d.s.
 o.d.s = overall depth of system

THK mm	o.d.s. mm	α_p , Practical sound absorption coefficient						α_w	Sound absorption class
		125 Hz	250 Hz	500 Hz	1000 Hz	2000 Hz	4000 Hz		
40	95	0.35	0.75	0.85	0.90	0.95	0.95	0.90	A
40	200	0.45	0.70	0.80	0.90	0.95	1.00	0.90	A

THK mm	o.d.s. mm	NRC	SAA
40	95	0.90	0.91
40	400	0.85	0.86

THK mm	AC(1.5)	D_{nfw}	CAC dB
	Articulation Class, ASTM E1111, ASTM E1110	Weighted normalized flanking level difference, ISO 10848-2	Ceiling Attenuation Class, ASTM 1414, ASTM E413
40	200	31	33

Indoor Air Quality



Certificate / Label	
Eurofins Indoor Air Comfort®	IAC
French VOC	A
Finnish M1	•



Environmental Footprint



	kg CO ₂ equiv/m ²
Master Ds	7,10

Life-cycle stages A1 to C4 from EPD, in conformity with ISO 14025 / EN 15804



Circularity

Minimum post-consumer recycled content	63%
Recyclability	Fully recyclable



Fire safety

Country	Class
Europe	EN 13501-1 A2-s1,d0

The glass wool core of the tiles is tested and classified as non-combustible according to EN ISO 1182.



Humidity Resistance

Class C, relative humidity 95% and 30°C, according to EN 13964:2014



Visual appearance

White Frost, nearest NCS colour sample S 0500-N, 85% light reflectance. Gloss < 1.



Cleanability

Daily dusting and vacuum cleaning. Weekly wet wiping.



Accessibility

The tiles are easily demountable. Minimum demounting depth according to installation diagrams.



Installation

Installed according to installation diagrams, installation guides and drawing aid. For information regarding minimum overall depth of system see quantity specification. The systems are not recommended for small rooms (approximately 2x2 m2). Ceilings with a large amount of integrations require careful planning, design and installation.



System weight

The weight of the system (including suspension grid) should be approximately 6 kg/m².



Mechanical properties

See table about Max live load and Min load bearing capacity and Functional demands, Mechanical properties at www.ecophon.com.



CE

Ecophon ceiling systems are CE marked according to the European harmonized standard EN 13964:2014. CE marked construction products are covered by a Declaration of Performance (DOP) which enables customers and users to easily compare performance of products available on the European market.

INSTALLATION DIAGRAM (M236) FOR ECOPHON MASTER DS, SUSPENDED INSTALLATION

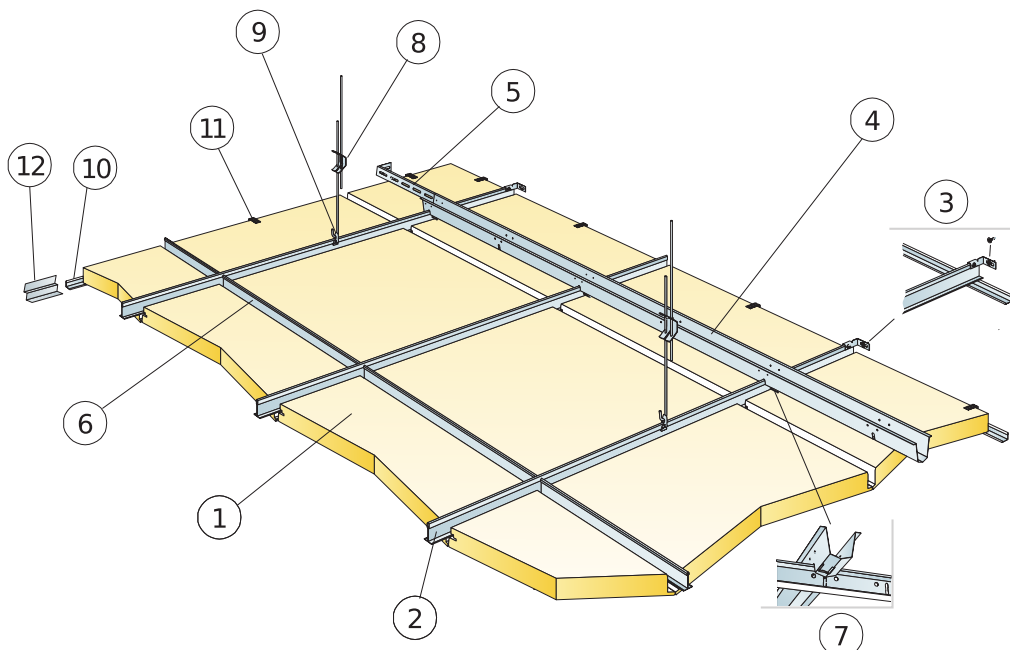

© Ecophon Group

QUANTITY SPECIFICATION (EXCL. WASTAGE)

		Size, mm
		600x600
1	Master Ds	2,8/m ²
2	Connect T24 Main Runner HD, installed at 600 mm centres	1,7m/m ²
3	Connect Wall Bracket for T-profiles	1/suspended row of Main runner
4	Connect Space Bar, installed at 1500 mm centres (max. distance from wall 300 mm)	0,7m/m ²
5	Connect Wall Bracket, L=700 mm, for Connect Space Bar	1/row of Space bar
6	Connect T24 Cross Tee, L=600 mm	2/row of Main runner
7	Connect Space Bar Winch, installed one per joint Connect Main Runner/Connect Space Bar	1,4/m ²
8	Connect Adjustable Hanger, installed at 1200 mm centres (max. distance from wall 600 mm)	0,7/m ²
9	Connect Hanger Clip (not to be used in swimming hall environments)	0,7/m ²
10	Connect Angle Trim, fixed at 300 mm centres	as required
11	Connect Perimeter tile clip 40	1/300-400mm on any cut edge
12	Connect Shadow-line Trim, fixed at 200 mm centres	as required
Δ Min. overall depth of system: 140 mm		-
δ Min. demounting depth: 50 mm		-
For luminaire integration in panels use Connect Bridging		-

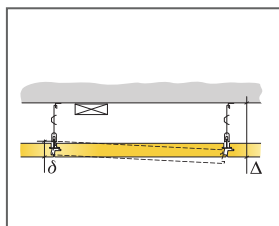

See Quantity specification

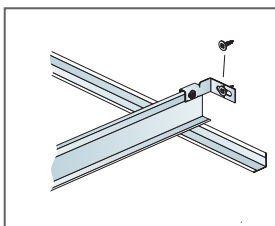

Connect Wall bracket for T-profiles

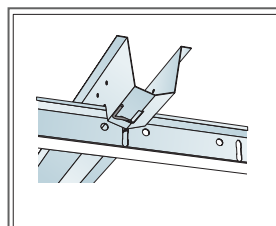

Connection between profiles with space bar winch

Size, mm	Max live load (N)	Min load bearing capacity (N)
600x600x40	40	160

Live load/load bearing capacity

INSTALLATION DIAGRAM (M242) FOR ECOPHON MASTER DS, DIRECT INSTALLATION

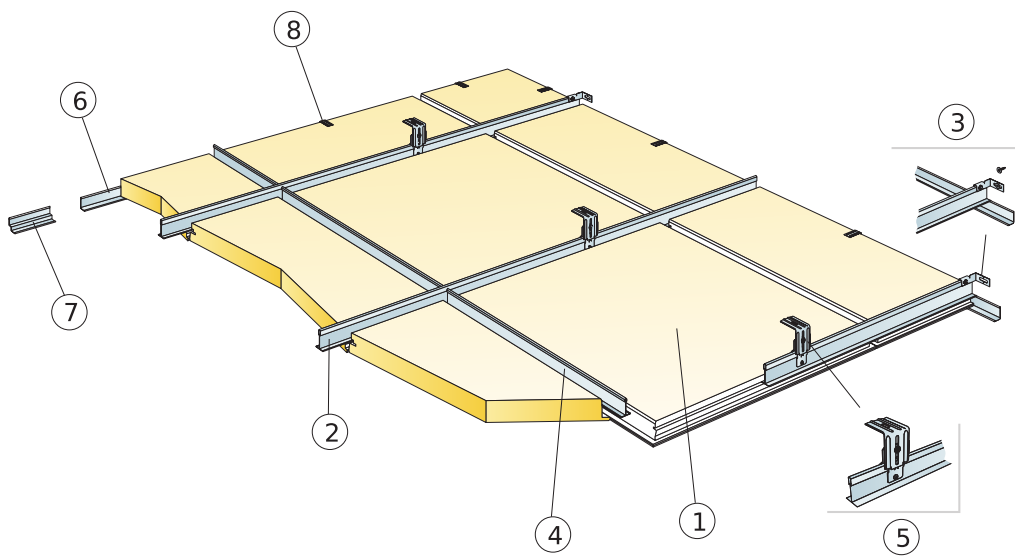

© Ecophon Group

QUANTITY SPECIFICATION (EXCL. WASTAGE)

	Size, mm
	600x600
1 Master Ds	2,8/m ²
2 Connect T24 Main Runner HD, installed at 600 mm centres	1,7m/m ²
3 Connect Wall Bracket for T-profiles	1/suspended row of Main runner
4 Connect T24 Cross Tee, L=600 mm	2/row of Main runner
5 Connect Adjust direct bracket, installed at 1500 mm centres	1,1/m ²
6 Connect Angle Trim, fixed at 300 mm centres	as required
7 Connect Shadow-line trim, fixed at 300 mm centres	as required
8 Connect Perimeter tile clip 40	1/300-400mm on any cut edge
Δ Min. overall depth of system: 95 mm	-
δ Min. demounting depth: 50 mm	-

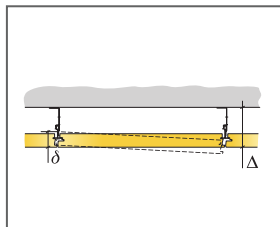

See Quantity specification

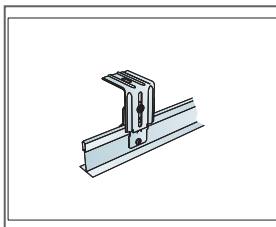

Suspension with direct bracket

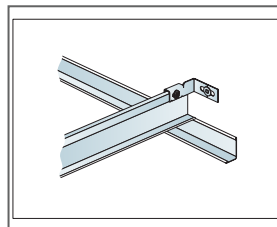

Profiles are fixed against the wall

Size, mm	Max live load (N)	Min load bearing capacity (N)
600x600x40	40	160

Live load/load bearing capacity

Ecophon Master™ E

Ecophon Master™ E has a recessed visible grid and a tegular edge design, creating a ceiling with a shadow effect that accentuates each tile and partially conceals the grid system. Suitable for open plan offices or other premises where strict demands are made on good acoustics.



SYSTEM RANGE

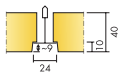

Size, mm	600x600	1200x600	1200x1200
Connect T15	•	•	
Connect T24	•	•	•
Thickness (THK)	40	40	40
Inst. Diagr.	M58	M58	M567

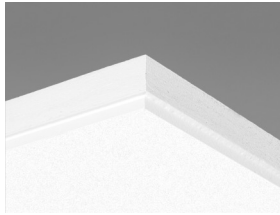

Master E tile

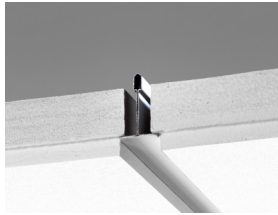

Section of Master E system

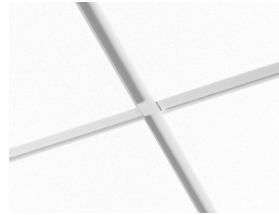

Master E system

Acoustic



Sound Absorption:

Test results according to EN ISO 354. Classification according to EN ISO 11654, and the single value ratings for Noise Reduction Coefficient, NRC and Sound Absorption Average, SAA according to ASTM C 423.

α_p , Practical sound absorption coefficient

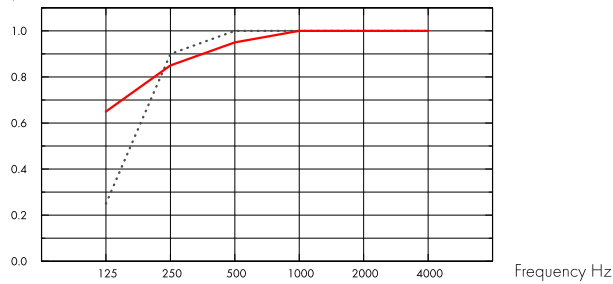

.... Master E 40 mm, 60 mm o.d.s.
 - Master E 40 mm, 200 mm o.d.s.
 o.d.s = overall depth of system

THK mm	o.d.s. mm	α_p , Practical sound absorption coefficient						α_w	Sound absorption class
		125 Hz	250 Hz	500 Hz	1000 Hz	2000 Hz	4000 Hz		
40	60	0.25	0.90	1.00	1.00	1.00	1.00	1.00	A
40	200	0.65	0.85	0.95	1.00	1.00	1.00	1.00	A

THK mm	o.d.s. mm	NRC	SAA
40	60	1.00	0.98
40	200	0.95	0.97
40	400	0.90	0.89

THK mm	AC[1.5] Articulation Class, ASTM E1111, ASTM E1110	D_{nfw} Weighted normalized flanking level difference, ISO 10848-2	CAC dB Ceiling Attenuation Class, ASTM 1414, ASTM E413
40	200	29	31

Indoor Air Quality



Certificate / Label	Plant	
Eurofins Indoor Air Comfort®	IAC	IAC Gold
French VOC	A	A+
Finnish M1	•	•





Environmental footprint

	kg CO ₂ equiv/m ²
Master E	6,10
Master E/Plant	4,15

Life-cycle stages A1 to C4 from EPD, in conformity with ISO 14025 / EN 15804



Circularity

Minimum post-consumer recycled content	61%
Recyclability	Fully recyclable



Fire safety

Country	Class	
Europe	EN 13501-1	A2-s1,d0

The glass wool core of the tiles is tested and classified as non-combustible according to EN ISO 1182.



Humidity Resistance

Product	
Standard	Class C, RH 95% and 30°C
Plant	Class A, RH 70% and 25°C

According to EN 13964:2014



Visual appearance

White Frost, nearest NCS colour sample S 0500-N, 85% light reflectance. Gloss < 1.



Cleanability

Daily dusting and vacuum cleaning. Weekly wet wiping.



Accessibility

The tiles are easily demountable. Minimum demounting depth according to installation diagrams.



Installation

Installed according to installation diagrams, installation guides and drawing aid. For information regarding minimum overall depth of system see quantity specification.



System weight

The weight of the system (including suspension grid) should be approximately 5 kg/m².



Mechanical properties

See table about Max live load and Min load bearing capacity and Functional demands, Mechanical properties at www.ecophon.com.



CE

Ecophon ceiling systems are CE marked according to the European harmonized standard EN13964:2014. CE marked construction products are covered by a Declaration of Performance (DOP) which enables customers and users to easily compare performance of products available on the European market.

INSTALLATION DIAGRAM (M58) FOR ECOPHON MASTER E

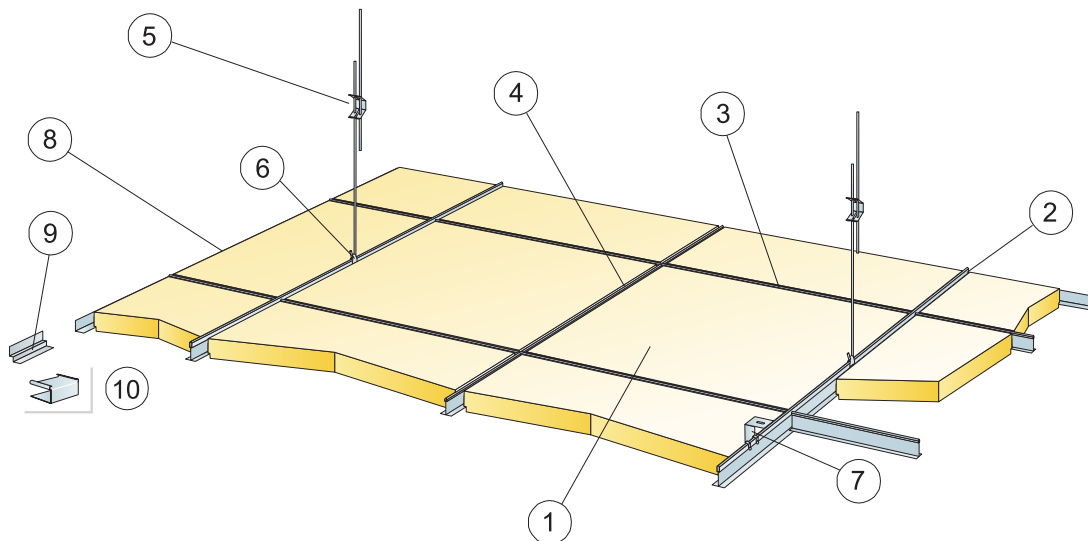

© Ecophon Group

QUANTITY SPECIFICATION (EXCL. WASTAGE)

	Size, mm	
	600x600	1200x600
1 Master E	2,8/m ²	1,4/m ²
2 Connect T24 or T15 Main runner, installed at 1200 mm centres (max. distance from wall 600 mm, can be extended up to 1200 mm if no live load between Main runner and wall).	0,9m/m ²	0,9m/m ²
3 Connect T24 or T15 Cross tee, L=1200 mm	1,7m/m ²	1,7m/m ²
4 Connect T24 or T15 Cross tee, L=600 mm	0,9m/m ²	-
5 Connect Adjustable Hanger, installed at 1200 mm centres (max. distance from wall 600 mm)	0,7/m ²	0,7/m ²
6 Connect Hanger Clip (not to be used in swimming hall environments)	0,7/m ²	0,7/m ²
7 For direct installation: Connect Direct Bracket, installed at 1200 mm centres	0,7/m ²	0,7/m ²
8 Connect Angle trim, fixed at 300 mm centres	as required	as required
9 Connect Shadow-line trim, fixed at 300 mm centres	as required	as required
10 Connect E-plug (for Shadow-line trim)	as required	as required
Δ Min. overall depth of system, with adjustable hanger: 110 mm, with direct bracket: 60 mm	-	-
δ Min. demounting depth: 170 mm	-	-

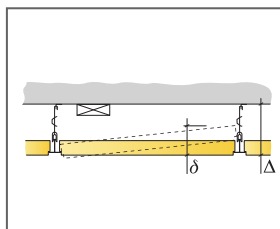

See Quantity specification

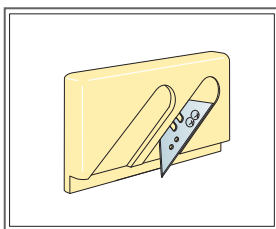

Cutting tool E

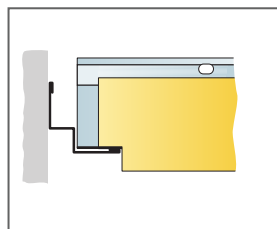

Regular rebate with shadow-line trim.

Size, mm	Max live load (N)	Min load bearing capacity (N)
600x600x40	40	160
1200x600x40	40	160

Live load/load bearing capacity

INSTALLATION DIAGRAM (M58) FOR ECOPHON MASTER E

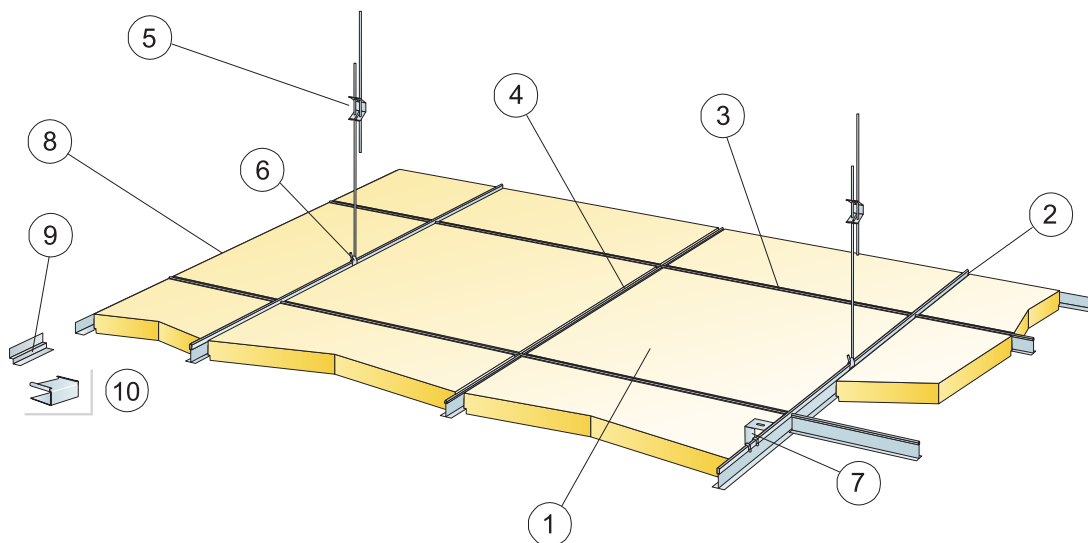

© Ecophon Group

QUANTITY SPECIFICATION (EXCL. WASTAGE)

	Size, mm
	1200x1200
1 Master E	0,7/m ²
2 Connect T24 Main runner, installed at 1200 mm centres (max. distance from wall 600 mm, can be extended up to 1200 mm if no live load between Main runner and wall).	0,9m/m ²
3 Connect T24 Cross tee, L=1200 mm, installed at 600 mm centres	0,9m/m ²
4 Connect T24 Cross tee, L=600 mm	-
5 Connect Adjustable Hanger, installed at 1200 mm centres (max. distance from wall 600 mm)	0,7/m ²
6 Connect Hanger Clip (not to be used in swimming hall environments)	0,7/m ²
7 For direct installation: Connect Direct Bracket, installed at 1200 mm centres	0,7/m ²
8 Connect Angle trim, fixed at 300 mm centres	as required
9 Connect Shadow-line trim, fixed at 300 mm centres	as required
10 Connect E-plug (for Shadow-line trim)	as required
Δ Min. overall depth of system, with adjustable hanger: 110 mm, with direct bracket: 60 mm	-
δ Min. demounting depth: 170 mm	-

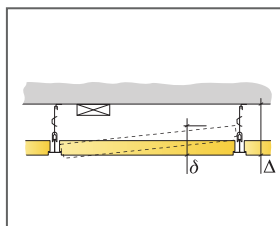

See Quantity specification

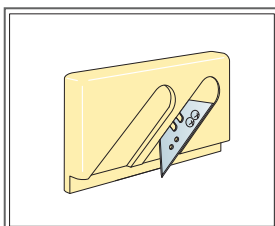

Cutting tool E

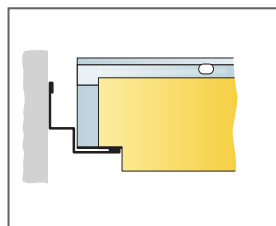

Regular rebate with shadow-line trim.

Size, mm	Max live load (N)	Min load bearing capacity (N)
1200x1200x40	40	160

Live load/load bearing capacity

Ecophon Master™ Eg

Ecophon Master™ Eg is a unique system that conceals the supporting tile edges, creating a distinctive floating appearance. Make an individual design with different panel sizes. Four supporting edges, makes it easy to install and demount. Suitable for open-plan offices or other premises where strict demands are made on good acoustics. Patent-pending system.



SYSTEM RANGE

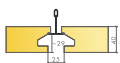

Size, mm	600x600	1200x600	1200x1200	XL 2400x600
T24	•	•	•	•
Thickness (THK)	40	40	40	40
Inst. Diagr.	M498, M500	M498, M499, M500	M498	M500

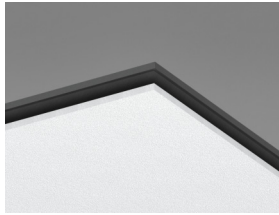

Master Eg tile

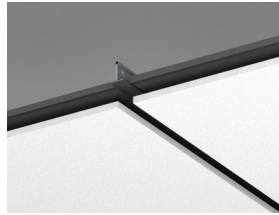

Section of Master Eg system

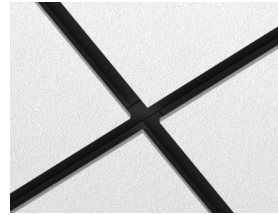

Master Eg system with malt black Connect grid

Acoustic



Sound Absorption:

Test results according to EN ISO 354. Classification according to EN ISO 11654.

α_p , Practical sound absorption coefficient

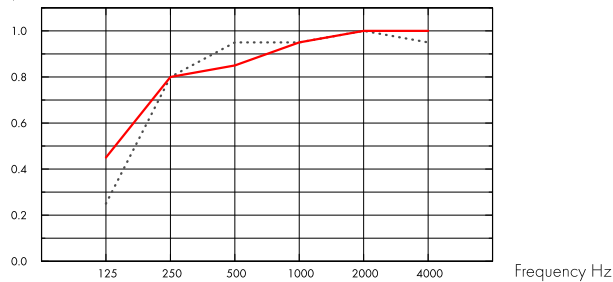

--- Master Eg 40 mm, 80 mm o.d.s.

— Master Eg 40 mm, 200 mm o.d.s.

o.d.s = overall depth of system

THK mm	o.d.s. mm	α_p , Practical sound absorption coefficient						α_w	Sound absorption class
		125 Hz	250 Hz	500 Hz	1000 Hz	2000 Hz	4000 Hz		
40	80	0.25	0.80	0.95	0.95	1.00	0.95	1.00	A
40	200	0.45	0.80	0.85	0.95	1.00	1.00	0.95	A

THK mm	AC(1.5)	
	Articulation Class, ASTM E1111, ASTM E1110	
40	200	

Indoor Air Quality



Certificate / Label	
Eurofins Indoor Air Comfort®	IAC
French VOC	A
Finnish M1	•



Environmental Footprint



	kg CO ₂ equiv/m ²
Master Eg	6,10

Life-cycle stages A1 to C4 from EPD, in conformity with ISO 14025 / EN 15804

Circularity



Minimum post-consumer recycled content	61%
Recyclability	Fully recyclable



Fire safety

Country	Class
Europe	EN 13501-1 A2-s1,d0

The glass wool core of the tiles is tested and classified as non-combustible according to EN ISO 1182.



Humidity Resistance

Class C, relative humidity 95% and 30°C, according to EN 13964:2014



Visual appearance

White Frost, nearest NCS colour sample S 0500-N, 85% light reflectance. Gloss < 1.



Cleanability

Daily dusting and vacuum cleaning. Weekly wet wiping.



Accessibility

The tiles are easily demountable. Minimum demounting depth according to installation diagrams.



Installation

Installed according to installation diagrams, installation guides and drawing aid. For information regarding minimum overall depth of system see quantity specification.



System weight

The weight of the system (including suspension grid) should be approximately 5 kg/m².



Mechanical properties

See table about Max live load and Min load bearing capacity and Functional demands, Mechanical properties at www.ecophon.com.



CE

Ecophon ceiling systems are CE marked according to the European harmonized standard EN 13964:2014. CE marked construction products are covered by a Declaration of Performance (DOP) which enables customers and users to easily compare performance of products available on the European market.

INSTALLATION DIAGRAM (M498) FOR ECOPHON MASTER EG

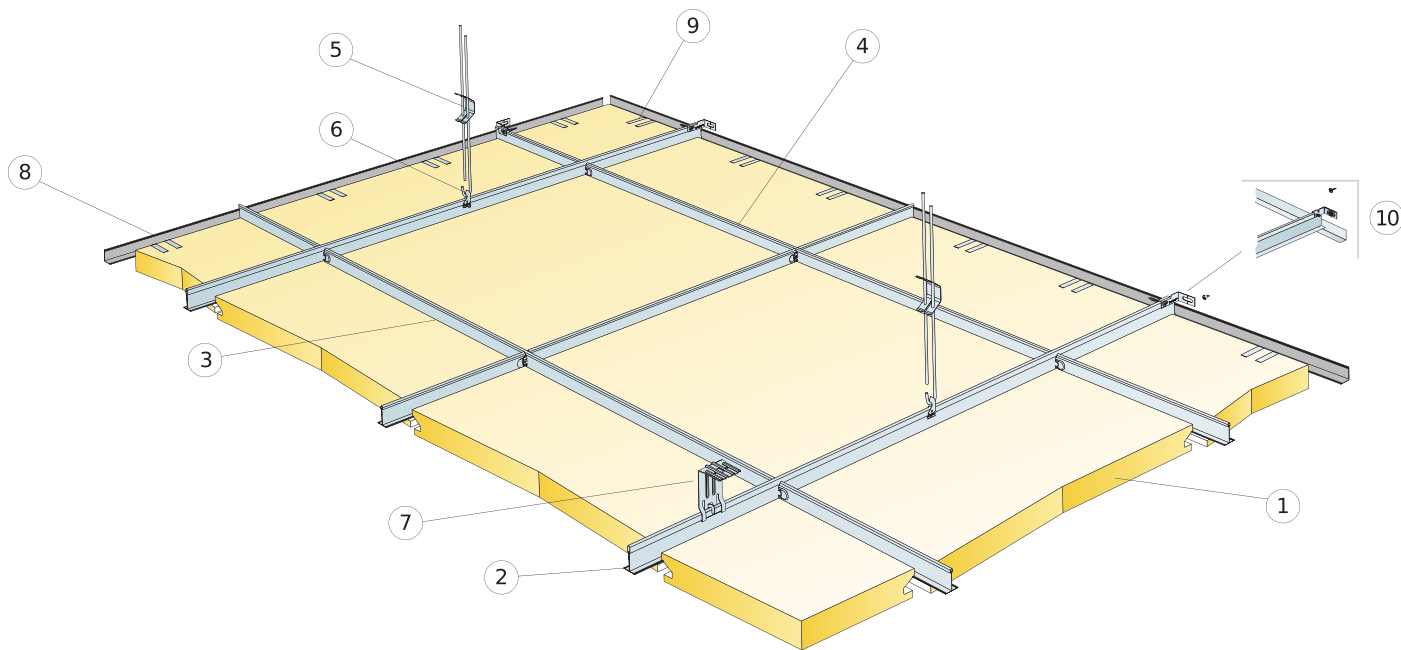

© Ecophon Group

QUANTITY SPECIFICATION (EXCL. WASTAGE)

	Size, mm		
	600x600	1200x600	1200x1200
1 Master Eg	2,8/m ²	1,4/m ²	0,7/m ²
2 Connect T24 Main runner, installed at 1200 mm centres (max. distance from wall 600 mm)	0,9m/m ²	0,9m/m ²	0,9m/m ²
3 Connect T24 Cross tee, L=1200 mm	1,7m/m ²	1,7m/m ²	0,9m/m ²
4 Connect T24 Cross tee, L=600 mm	0,9m/m ²	-	-
5 Connect Adjustable Hanger, installed at 1200 mm centres (max. distance from wall 600 mm)	0,7/m ²	0,7/m ²	0,7/m ²
6 Connect Hanger Clip (not to be used in swimming hall environments)	0,7/m ²	0,7/m ²	0,7/m ²
7 For direct installation: Connect Direct Bracket, installed at 1200 mm centres	0,7/m ²	0,7/m ²	0,7/m ²
8 Connect Angle trim, fixed at 300 mm centres	as required	as required	as required
9 Connect Support clip DG25	1/300-400mm on any cut edge		
10 Connect Wall Bracket for T-profiles	1/suspended row of Main runner		
Δ Min. overall depth of system, with adjustable hanger: 130 mm, with direct bracket: 80 mm	-	-	-
δ Min. demounting depth: 170 mm, 180mm with 1200x1200	-	-	-
For luminaire integration in panels use Connect Bridging	-	-	-

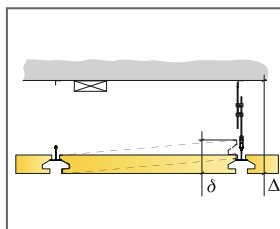

See Quantity specification

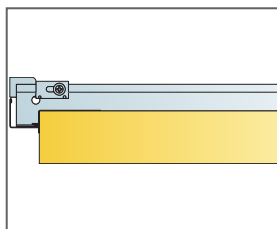

Straight cut edge with support clip. T-profiles resting on Angle trim.

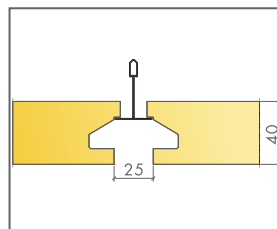

Lay in panel with edge design for floating ceiling appearance

Size, mm	Max live load (N)	Min load bearing capacity (N)
600x600x40	40	160
1200x600x40	40	160
1200x1200x40	40	160

Live load/load bearing capacity

INSTALLATION DIAGRAM (M499) FOR ECOPHON MASTER EG

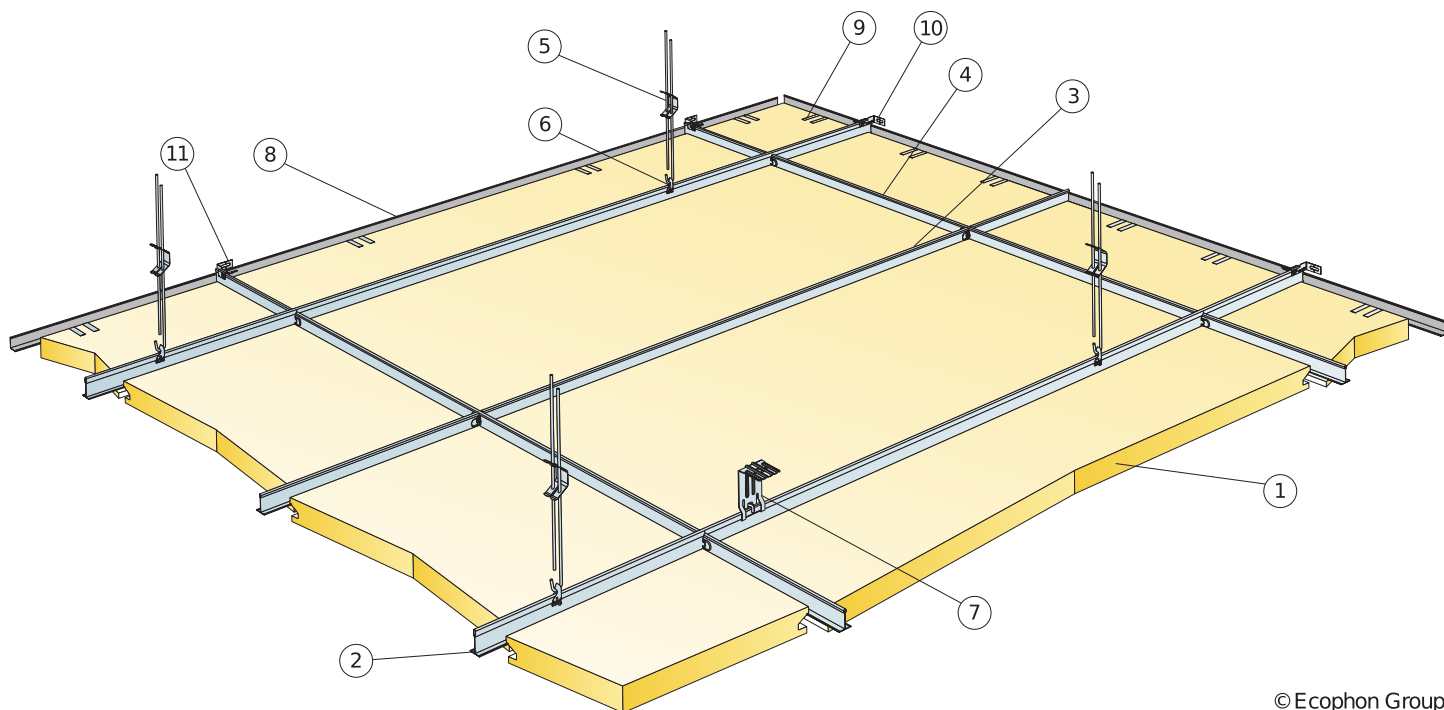

© Ecophon Group

QUANTITY SPECIFICATION (EXCL. WASTAGE)

		Size, mm
		1200x600
1	Master Eg	1,4/m ²
2	Connect T24 Main runner, installed at 1200 mm centres (max. distance from wall 600 mm)	0,9m/m ²
3	Connect T24 Cross tee, L=1200 mm	0,85m/m ²
4	Connect T24 Cross tee, L=1200 mm	0,85m/m ²
5	Connect Adjustable Hanger, installed at 1200 mm centres (max. distance from wall 600 mm)	0,7/m ²
6	Connect Hanger Clip (not to be used in swimming hall environments)	0,7/m ²
7	For direct installation: Connect Direct Bracket, installed at 1200 mm centres	0,7/m ²
8	Connect Angle trim, fixed at 300 mm centres	as required
9	Connect Support clip DG25	1/300-400mm on any cut edge
10	Connect Wall Bracket for Main runners	1/suspended row of Main runner
11	Connect Wall Bracket for Cross tees	1/row of cross tee
Δ Min. overall depth of system, with adjustable hanger: 130 mm, with direct bracket: 80 mm		-
δ Min. demounting depth: 170 mm		-
For luminaire integration in panels use Connect Bridging		-

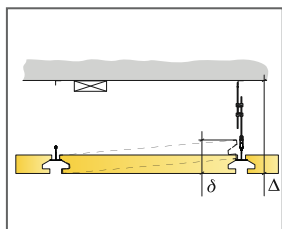

See Quantity specification

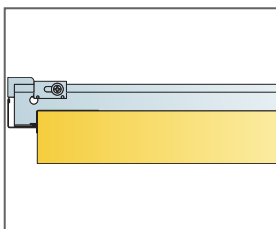

Straight cut edge with support clip. T-profiles resting on Angle trim.

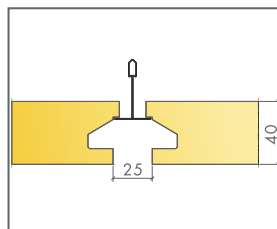

Lay in panel with edge design for floating ceiling appearance

Size, mm	Max live load (N)	Min load bearing capacity (N)
1200x600x40	40	160

Live load/load bearing capacity

INSTALLATION DIAGRAM (M500) FOR ECOPHON MASTER EG

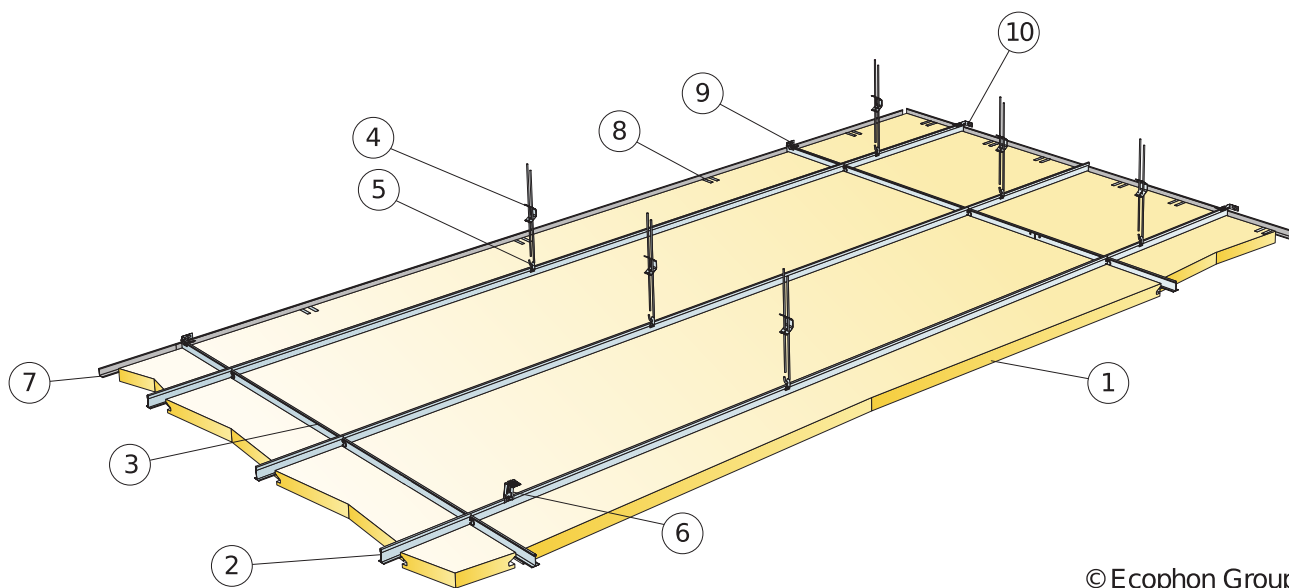

© Ecophon Group

QUANTITY SPECIFICATION (EXCL. WASTAGE)

	Size, mm		
	600x600	1200x600	2400x600
1 Master Eg	2,8/m ²	1,4/m ²	0,7/m ²
2 Connect T24 Main runner, installed at 600 mm centres (max. distance from wall 600 mm)	1,7m/m ²	1,7m/m ²	1,7m/m ²
3 Connect T24 Cross tee, L=600 mm	1,7m/m ²	0,9m/m ²	0,45m/m ²
4 Connect Adjustable Hanger, installed at 1500 mm centres (max. distance from wall 600 mm)	1,1/m ²	1,1/m ²	1,1/m ²
5 Connect Hanger Clip (not to be used in swimming hall environments)	1,1/m ²	1,1/m ²	-
6 For direct installation: Connect Direct Bracket, installed at 1500 mm centres	1,1/m ²	1,1/m ²	1,1/m ²
7 Connect Angle trim, fixed at 300 mm centres	as required	as required	as required
8 Connect Support clip DG25	2/500-600mm on any cut edge	2/500-600mm on any cut edge	1/500-600mm on any cut edge
9 Connect Wall Bracket for Cross tees	0,25/row of cross tee	0,5/row of cross tee	1/row of cross tee
10 Connect Wall Bracket for Main runners	1/second row of Main runner		
Δ Min. overall depth of system, with adjustable hanger: 130 mm, with direct bracket: 80 mm	-	-	-
δ Min. demounting depth: 170 mm	-	-	-
For luminaire integration in panels use Connect Bridging	-	-	-

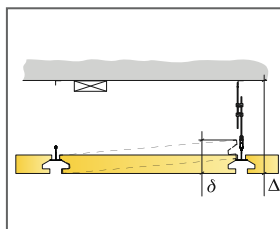

See Quantity specification

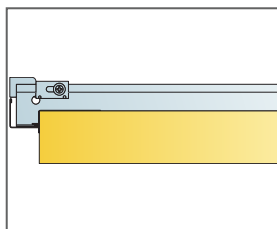

Straight cut edge with support clip. T-profiles resting on Angle trim.

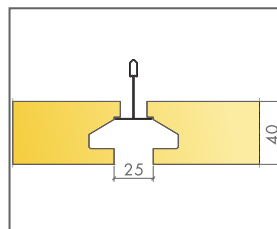

Lay in panel with edge design for floating ceiling appearance

Size, mm	Max live load (N)	Min load bearing capacity (N)
600x600x40	40	160
1200x600x40	40	160
2400x600x40	40	160

Live load/load bearing capacity

Ecophon Master™ F

Ecophon Master™ F is installed directly to an existing plaster ceiling, boarding, battens or concrete to create a ceiling with a smooth appearance. Suitable for schools, open plan offices or other premises where strict demands are made on good acoustics.



Walkenried Kindergarten, Walkenried, Germany

SYSTEM RANGE

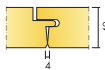

Size, mm	600x600	1200x600
Direct	•	•
Thickness (THK)	40	40
Inst. Diag.	M52	M52

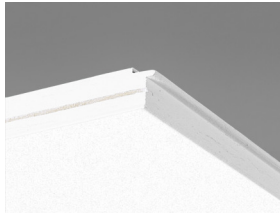

Master F tile

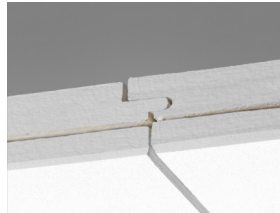

Section of Master F system with tongue and groove



Master F system



Master F is installed by screw fixing

Acoustic



Sound Absorption:

Test results according to EN ISO 354. Classification according to EN ISO 11654, and the single value ratings for Noise Reduction Coefficient, NRC and Sound Absorption Average, SAA according to ASTM C 423.

α_p , Practical sound absorption coefficient

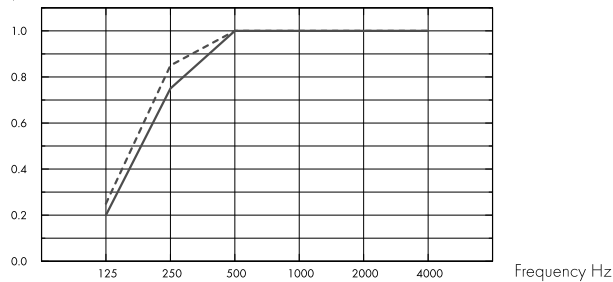

- Master F 40 mm, 40 mm o.d.s.
 - Master F 40 mm, 60 mm o.d.s.
- o.d.s = overall depth of system

THK mm	o.d.s. mm	α_p , Practical sound absorption coefficient						α_w	Sound absorption class
		125 Hz	250 Hz	500 Hz	1000 Hz	2000 Hz	4000 Hz		
40	40	0.20	0.75	1.00	1.00	1.00	1.00	1.00	A
40	60	0.25	0.85	1.00	1.00	1.00	1.00	1.00	A

THK mm	o.d.s. mm	NRC	SAA
40	40	0.95	0.96
40	60	0.95	0.98

Indoor Air Quality



Certificate / Label	
Eurofins Indoor Air Comfort®	IAC
French VOC	A
Finnish M1	•



Environmental Footprint



	kg CO ₂ equiv/m ²
Master F	7,30

Life-cycle stages A1 to C4 from EPD, in conformity with ISO 14025 / EN 15804

Circularity



Minimum post-consumer recycled content	63%
Recyclability	Fully recyclable



Fire safety

Country	Class	
Europe	EN 13501-1	A2-s1,d0

The glass wool core of the tiles is tested and classified as non-combustible according to EN ISO 1182.



Humidity Resistance

Class C, relative humidity 95% and 30°C, according to EN 13964:2014



Visual appearance

White Frost, nearest NCS colour sample S 0500-N, 85% light reflectance. Gloss < 1.



Cleanability

Daily dusting and vacuum cleaning. Weekly wet wiping.



Accessibility

The tiles are not demountable.



Installation

Installed according to installation diagrams, installation guides and drawing aid. For information regarding minimum overall depth of system see quantity specification. For best result the surface should be even, however an acceptable result could be achieved on slightly uneven surfaces. If very uneven surfaces - installation of furring (evenly spaced timber battens) as the substrate for the tiles is recommended.



System weight

The weight of the system should be approximately 5 kg/m².



Mechanical properties

Additional live load has to be fixed to the soffit.



CE

Ecophon ceiling systems are CE marked according to the European harmonized standard EN13964:2014. CE marked construction products are covered by a Declaration of Performance (DOP) which enables customers and users to easily compare performance of products available on the European market.

INSTALLATION DIAGRAM (M52) FOR ECOPHON MASTER F

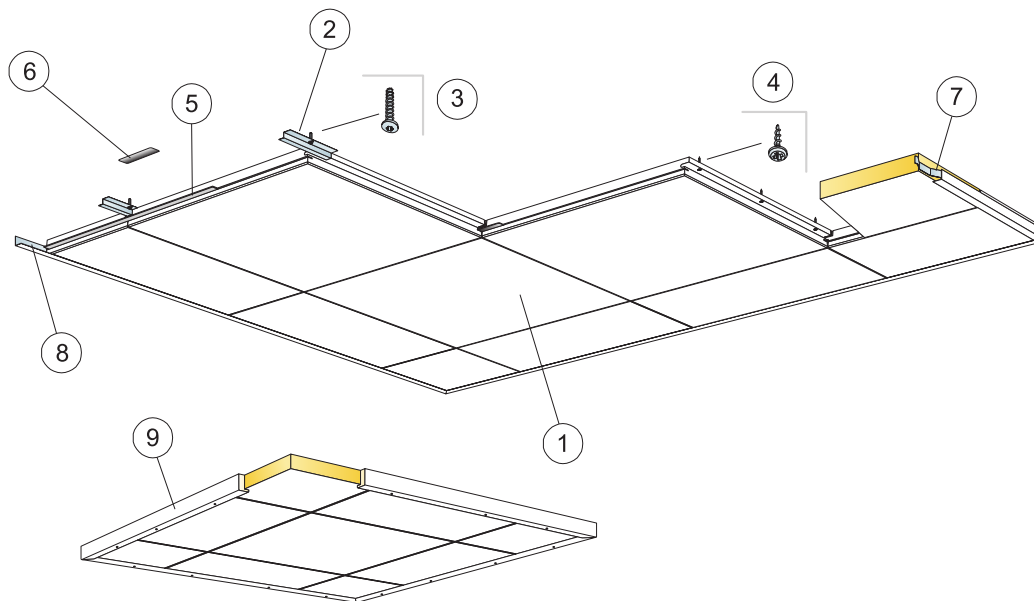

© Ecophon Group

QUANTITY SPECIFICATION (EXCL. WASTAGE)

	Size, mm	
	600x600	1200x600
1 Master F	2,8/m ²	1,4/m ²
2 Connect Direct fixing plate F 0152, installed at 600 mm centres (for use in concrete)	2,8/m ²	2,8/m ²
3 Connect Anchor screw, installed at 600 mm centres (for use in concrete)	2,8/m ²	2,8/m ²
4 Connect Installation screw MVL (for use in plasterboard or timber)	8,3/m ²	7/m ²
5 Connect Spline F, L=600 mm. Must be used in Sweden, Denmark, Norway and Finland at fireclass 'Tändskyddande beklädnad'	2,8/m ²	1,4/m ²
6 Connect Spline, L=150 mm	2,8/m ²	1,4/m ²
7 Connect Wall spring spacer	1/panel in the last row	2/panel in the last row
8 Connect Angle trim, fixed at 300 mm centres	as required	as required
9 When installing floating ceilings: Connect Wood trim, L=3000, fixed at 500 mm centres	as required	as required
Δ Min. overall depth of system: 40 mm	-	-
δ Min. demounting depth: The system is not demountable	-	-

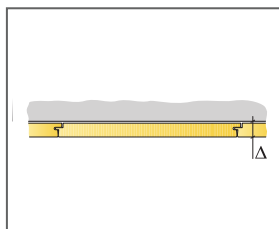

See Quantity specification

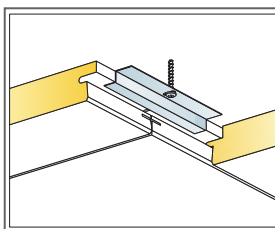

Installation in concrete

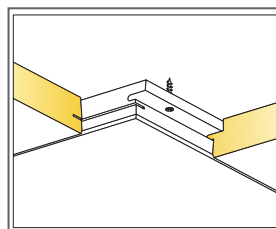

Installation in plasterboard or timber

Size, mm	Max live load (N)	Min load bearing capacity (N)
600x600x40	-	-
1200x600x40	-	-

Live load/load bearing capacity

Ecophon Master™ SQ

Ecophon Master™ SQ has bonded tiles directly to the soffit surface. Installed with a gap between each tile the result is a ceiling with a smooth appearance. Suitable for schools, open plan offices or other premises where strict demands are made on good acoustics.



AWO Seniorenzentrum, Wehl, Germany

SYSTEM RANGE



Size, mm	600x600	1200x600
Direct	•	•
Thickness (THK)	40	40
Inst. Diag.	M106	M106

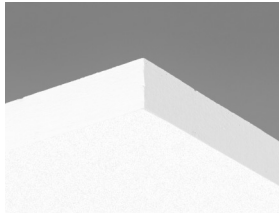

Master SQ tile

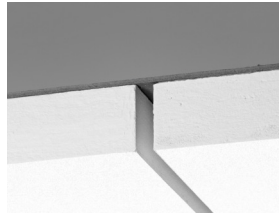

Section of Master SQ system

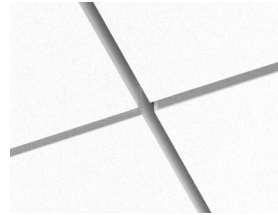

Master SQ system

Acoustic



Sound Absorption:

Test results according to EN ISO 354. Classification according to EN ISO 11654.

α_p , Practical sound absorption coefficient

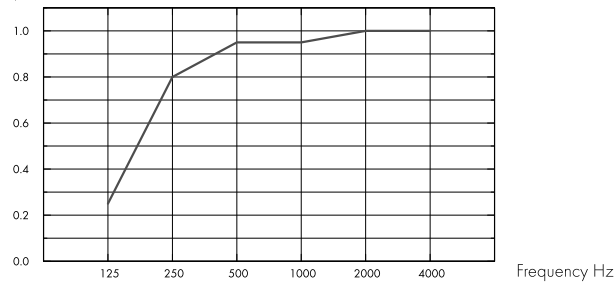

– Master SQ 40 mm, 43 mm o.d.s.

o.d.s = overall depth of system

THK mm	o.d.s. mm	α_p , Practical sound absorption coefficient						α_w	Sound absorption class
		125 Hz	250 Hz	500 Hz	1000 Hz	2000 Hz	4000 Hz		
40	43	0.25	0.80	0.95	0.95	1.00	1.00	1.00	A



Indoor Air Quality

Certificate / Label	
Eurofins Indoor Air Comfort®	IAC
French VOC	A
Finnish M1	•



Environmental Footprint

	kg CO ₂ equiv/m ²
Master SQ	7,20

Life-cycle stages A1 to C4 from EPD, in conformity with ISO 14025 / EN 15804



Circularity

Minimum post-consumer recycled content	62%
Recyclability	Fully recyclable



Fire safety

Country	Class	
Europe	EN 13501-1	A2-s1,d0

The glass wool core of the tiles is tested and classified as non-combustible according to EN ISO 1182.



Humidity Resistance

Class C, relative humidity 95% and 30°C, according to EN 13964:2014



Visual appearance

White Frost, nearest NCS colour sample S 0500-N, 85% light reflectance. Gloss < 1.



Cleanability

Daily dusting and vacuum cleaning. Weekly wet wiping.



Accessibility

The tiles are not demountable.



Installation

Installed according to installation diagrams, installation guides and drawing aid. For information regarding minimum overall depth of system see quantity specification. Rendered surfaces must have sufficient strength to be able to carry the load imposed by the tiles. If doubts, test gluing should be carried out. The surface should always be dry and clean. For best result the surface should be even, however an acceptable result could be achieved on slightly uneven surfaces.



System weight

The weight of the system should be approximately 5 kg/m².



Mechanical properties

Additional live load has to be fixed to the soffit.



CE

Ecophon ceiling systems are CE marked according to the European harmonized standard EN 13964:2014. CE marked construction products are covered by a Declaration of Performance (DOP) which enables customers and users to easily compare performance of products available on the European market.

INSTALLATION DIAGRAM (M106) FOR ECOPHON MASTER SQ, USING CONNECT ABSORBER GLUE

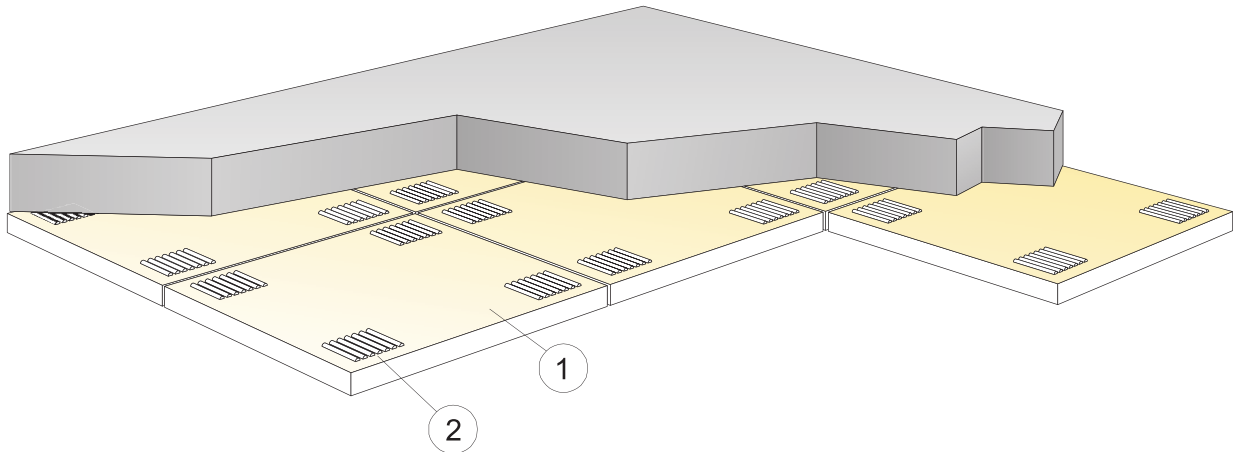

© Ecophon Group

QUANTITY SPECIFICATION (EXCL. WASTAGE)

	Size, mm	
	600x600	1200x600
1 Master SQ	2,8/m ²	1,4/m ²
2 Connect Absorber glue (0,25 l/m ² - 0,4 l/m ² depending on installation conditions)	as required	as required
Use Connect Notched spatula to apply the glue.	-	-
Δ Min. overall depth of system: 43 mm	-	-
δ Min. demounting depth: The system is not demountable	-	-
Visible edges should be painted	-	-
* Panel Module size 600x600 [592x592], 1200x600 [1192x592]	-	-

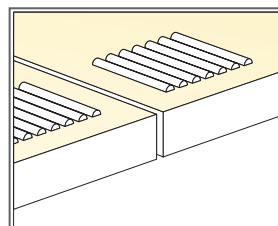
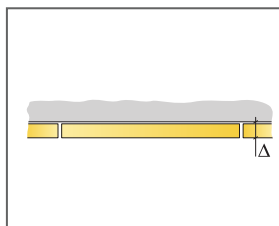

Application of glue

Size, mm	Max live load (N)	Min load bearing capacity (N)
600x600x40	-	-
1200x600x40	-	-

Live load/load bearing capacity

Ecophon Master™ Rigid A

Ecophon Master™ Rigid A has an exposed grid system. Each tile is secured in the grid by clips and is fully demountable. The surface is a reinforced sandwich construction. Used together with Ecophon Extra Bass, optimal acoustics are achieved.



Bewley School, West Hurslet, United Kingdom

SYSTEM RANGE

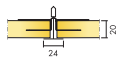

Size, mm	600x600	1200x600	XL 1600x600	XL 1800x600	XL 2000x600	XL 2400x600
Extra Bass	•	•				
T24	•	•	•	•	•	•
Thickness (THK)	20	20	20	20	20	20
Inst. Diagr.	M316EB	M316EB	M333	M333	M333	M333

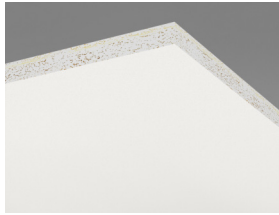

Master Rigid A tile

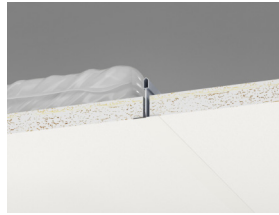

Section of Master Rigid A system with Connect T24

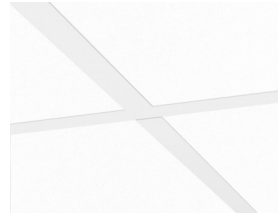

Master Rigid A system with Connect T24

Acoustic



Sound Absorption:

Test results according to EN ISO 354. Classification according to EN ISO 11654.

α_p , Practical sound absorption coefficient

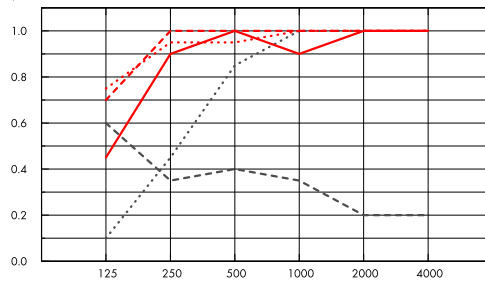

- Master Rigid A 20 mm, 50 mm o.d.s.
- Master Rigid A 20 mm, 200 mm o.d.s.
- - - Master Rigid A 20 mm + Extra Bass 50 mm, 200 mm o.d.s.
- Master Rigid A 20 mm + 2xExtra Bass 100 mm, 200 mm o.d.s.
- - - Master Rigid A gamma 20 mm, 200 mm o.d.s.

o.d.s = overall depth of system

	THK mm	o.d.s. mm	α_p , Practical sound absorption coefficient						α_w	Sound absorption class
			125 Hz	250 Hz	500 Hz	1000 Hz	2000 Hz	4000 Hz		
-	20	50	0.10	0.45	0.85	1.00	1.00	1.00	0.75	C
-	20	200	0.45	0.90	1.00	0.90	1.00	1.00	1.00	A
+ Extra Bass	70	200	0.70	1.00	1.00	1.00	1.00	1.00	1.00	A
+ 2xExtra Bass	120	200	0.75	0.95	0.95	1.00	1.00	1.00	1.00	A
gamma	20	200	0.60	0.35	0.40	0.35	0.20	0.20	0.30	D

THK mm	o.d.s. mm	NRC	SAA
20	50	0.80	0.83
20	200	0.95	0.93
70	200	1.00	1.00
20	200	0.35	0.33

Indoor Air Quality



Certificate / Label	
Eurofins Indoor Air Comfort®	IAC
French VOC	A
Finnish M1	•



Environmental Footprint



	kg CO ₂ equiv/m ²
Master Rigid A	2,95

Life-cycle stages A1 to C4 from EPD, in conformity with ISO 14025 / EN 15804



Circularity

Minimum post-consumer recycled content	46%
Recyclability	Fully recyclable



Fire safety

Country	Class	
Europe	EN 13501-1	A2-s1,d0

The glass wool core of the tiles is tested and classified as non-combustible according to EN ISO 1182.



Humidity Resistance

Class C, relative humidity 95% and 30°C, according to EN 13964:2014



Visual appearance

White Frost, nearest NCS colour sample S 0500-N, 85% light reflectance. Gloss < 1.



Cleanability

Daily dusting and vacuum cleaning. Weekly wet wiping.



Accessibility

The tiles are secured in the grid, but demountable. Minimum demounting depth according to installation diagrams.



Installation

Installed according to installation diagrams, installation guides and drawing aid. For information regarding minimum overall depth of system see quantity specification.



System weight

The weight of the system (including suspension grid and Extra Bass) should be approximately 3,5 kg/m².



Mechanical properties

See table regarding the min- and max- load bearing capacities and functional demands.



Impact Resistance

M-sketch	
M316	3A



CE

Ecophon ceiling systems are CE marked according to the European harmonized standard EN13964:2014. CE marked construction products are covered by a Declaration of Performance (DOP) which enables customers and users to easily compare performance of products available on the European market.

INSTALLATION DIAGRAM (M316EB) FOR ECOPHON MASTER RIGID A

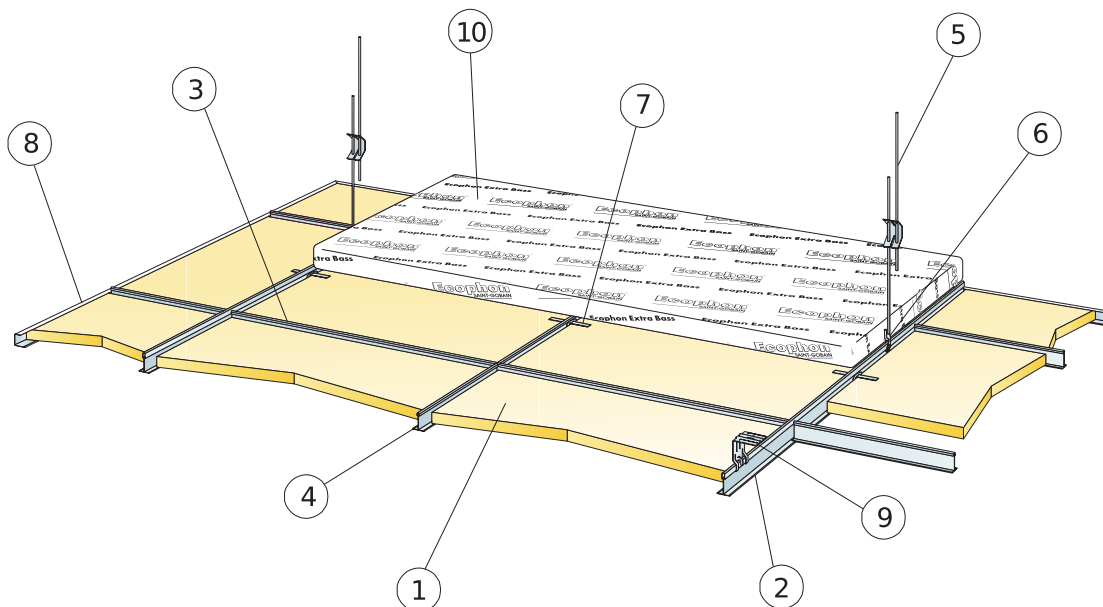

© Ecophon Group

QUANTITY SPECIFICATION (EXCL. WASTAGE)

	Size, mm	
	600x600	1200x600
1 Master Rigid A	2,8/m ²	1,4/m ²
2 Connect T24 Main runner, installed at 1200 mm centres (max. distance from wall 600 mm, can be extended up to 1200 mm if no live load between Main runner and wall).	0,9/m ²	0,9/m ²
3 Connect T24 Cross tee, L=1200 mm, installed at 600 mm centres	1,7/m ²	1,7/m ²
4 Connect T24 Cross tee, L=600 mm	0,9/m ²	-
5 Connect Adjustable Hanger, installed at 1200 mm centres (max. distance from wall 600 mm)	0,7/m ²	0,7/m ²
6 Connect Hanger Clip (not to be used in swimming hall environments)	0,7/m ²	0,7/m ²
7 Connect Hold down clip A	2pcs/panel	2pcs/panel
8 Connect Channel trim, fixed at c300 mm (1200x1200, c200 mm)	as required	as required
9 For direct installation: Connect Direct bracket, installed at 1200 mm centres	0,7/m ²	0,7/m ²
10 Extra Bass (1200x600x50 mm)	0,7/m ²	0,7/m ²
11 Connect Demounting tool	-	-
Δ Min. overall depth of system: 100 mm	-	-
δ Min. demounting depth: 120 mm (tiles without Extra Bass above)	-	-
For luminaire integration in panels use Connect Bridging	-	-

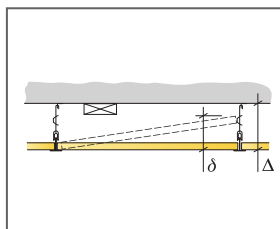

See Quantity specification

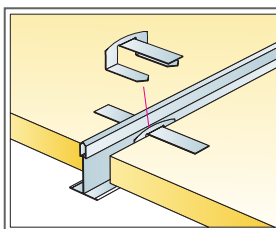

Connect Hold down clip A (patented)

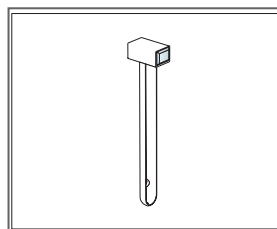

Connect Demounting tool

Size, mm	Max live load (N)	Min load bearing capacity (N)
600x600x20	50	160
1200x600x20	50	160

Live load/load bearing capacity

INSTALLATION DIAGRAM (M333) FOR ECOPHON MASTER RIGID A XL IN CORRIDORS

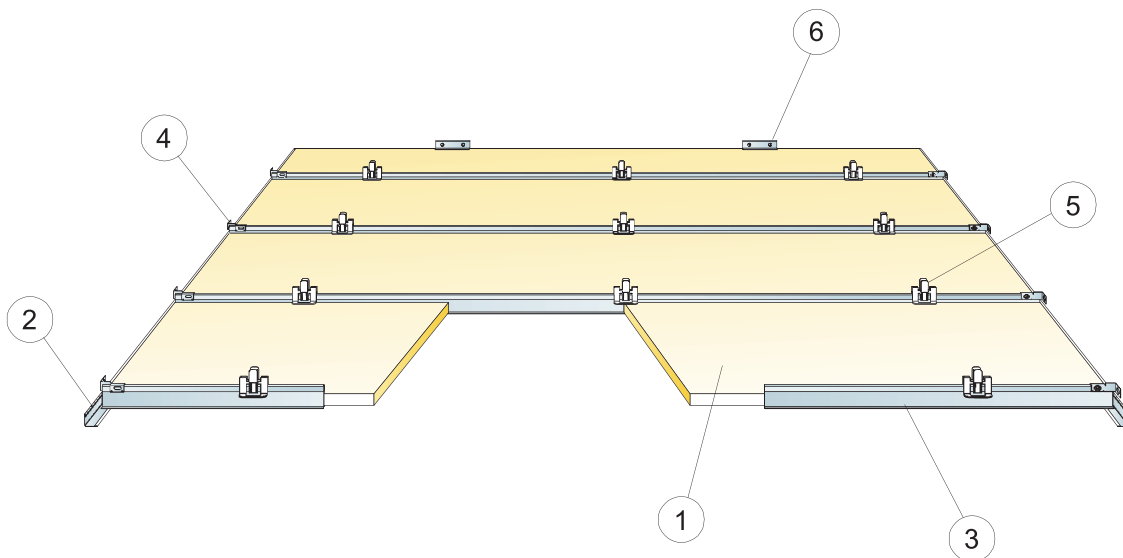

© Ecophon Group

QUANTITY SPECIFICATION (EXCL. WASTAGE)

	Size, mm			
	1600x600	1800x600	2000x600	2400x600
1 Master Rigid A XL	1,05/m ²	0,95/m ²	0,85/m ²	0,7/m ²
2 Connect Angle trim, fixed at 200 mm centres	as required	as required	as required	as required
3 Connect T24 Corridor profile, installed at 600 mm centres	1,05/m ²	0,95/m ²	0,85/m ²	0,7/m ²
4 Connect Wall bracket for T-profiles	2 for every row of corridor profile			
5 Connect Hygiene clip 20	3,15/m ² (3/tile)	2,8/m ² (3/tile)	2,5/m ² (3/tile)	2,1/m ² (3/tile)
6 Connect Angle trim	as required	as required	as required	as required
Δ Min. overall depth of system: 150 mm	-	-	-	-
δ Min. demounting depth: 150 mm	-	-	-	-

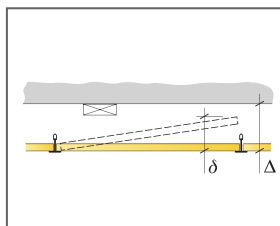

See Quantity specification

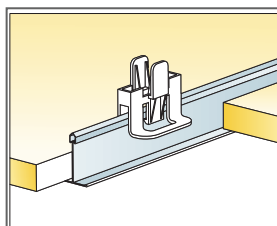

Clip for keeping tiles in place

Size, mm	Max live load (N)	Min load bearing capacity (N)
1600x600x20	40	-
1800x600x20	20	-
2000x600x20	10	-
2400x600x20	0	-

Live load/load bearing capacity

Ecophon Master™ Rigid Dp

Ecophon Master™ Rigid Dp is a patented, semi-concealed grid system for use when a lockable, impact resistant system is required. Features a reinforced sandwich construction. For classrooms or other spaces that require good acoustics and speech intelligibility, and can also be demounted.



SYSTEM RANGE

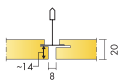

Size, mm	600x600	1200x600
Extra Bass	•	•
T24	•	•
Thickness (THK)	20	20
Inst. Diagr.	M318EB, M319	M318EB, M319



Master Rigid Dp tile

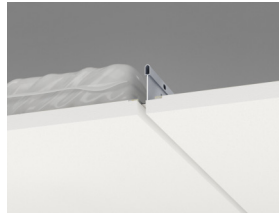

Section of Master Rigid Dp system with Connect T24

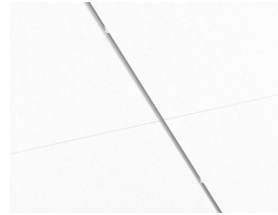

Master Rigid Dp system with Connect T24

Acoustic



Sound Absorption:

Test results according to EN ISO 354. Classification according to EN ISO 11654.

α_p , Practical sound absorption coefficient

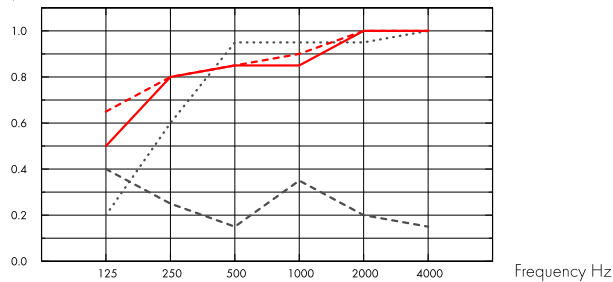

- Master Rigid Dp 20 mm, 65 mm o.d.s.
 - Master Rigid Dp 20 mm, 200 mm o.d.s.
 - - - Master Rigid Dp 20 mm + Extra Bass 50 mm, 200 mm o.d.s.
 - - - Master Rigid Dp gamma 20 mm, 200 mm o.d.s.
- o.d.s = overall depth of system

	THK mm	o.d.s. mm	α_p , Practical sound absorption coefficient					α_w	Sound absorption class	
			125 Hz	250 Hz	500 Hz	1000 Hz	2000 Hz			4000 Hz
-	20	65	0.20	0.60	0.95	0.95	0.95	1.00	0.90	A
-	20	200	0.50	0.80	0.85	0.85	1.00	1.00	0.90	A
+ Extra Bass	70	200	0.65	0.80	0.85	0.90	1.00	1.00	0.90	A
gamma	20	200	0.40	0.25	0.15	0.35	0.20	0.15	0.20	E

Indoor Air Quality



Certificate / Label	
Eurofins Indoor Air Comfort®	IAC
French VOC	A
Finnish M1	•



Environmental Footprint



	kg CO ₂ equiv/m ²
Master Rigid Dp	4,95
Extra Bass	1,62

Life-cycle stages A1 to C4 from EPD, in conformity with ISO 14025 / EN 15804

Circularity



Minimum post-consumer recycled content	55%
Recyclability	Fully recyclable

Fire safety



Country	Class
Europe	EN 13501-1 A2-s1,d0

The glass wool core of the tiles is tested and classified as non-combustible according to EN ISO 1182.



Humidity Resistance

Class C, relative humidity 95% and 30°C, according to EN 13964:2014



Visual appearance

White Frost, nearest NCS colour sample S 0500-N, 85% light reflectance. Gloss < 1.



Cleanability

Daily dusting and vacuum cleaning. Weekly wet wiping.



Accessibility

The tiles are secured in the grid, but demountable. Minimum demounting depth according to installation diagrams.



Installation

Installed according to installation diagrams, installation guides and drawing aid. For information regarding minimum overall depth of system see quantity specification.



System weight

The weight of the system (including suspension grid and Extra Bass) should be approximately 4 kg/m².



Mechanical properties

See table regarding the min- and max- load bearing capacities and functional demands.



Impact Resistance

M-sketch

Tested and classified according to EN 13964 annex D.

M318

3A



CE

Ecophon ceiling systems are CE marked according to the European harmonized standard EN 13964:2014. CE marked construction products are covered by a Declaration of Performance (DOP) which enables customers and users to easily compare performance of products available on the European market.

INSTALLATION DIAGRAM (M318EB) FOR ECOPHON MASTER RIGID DP

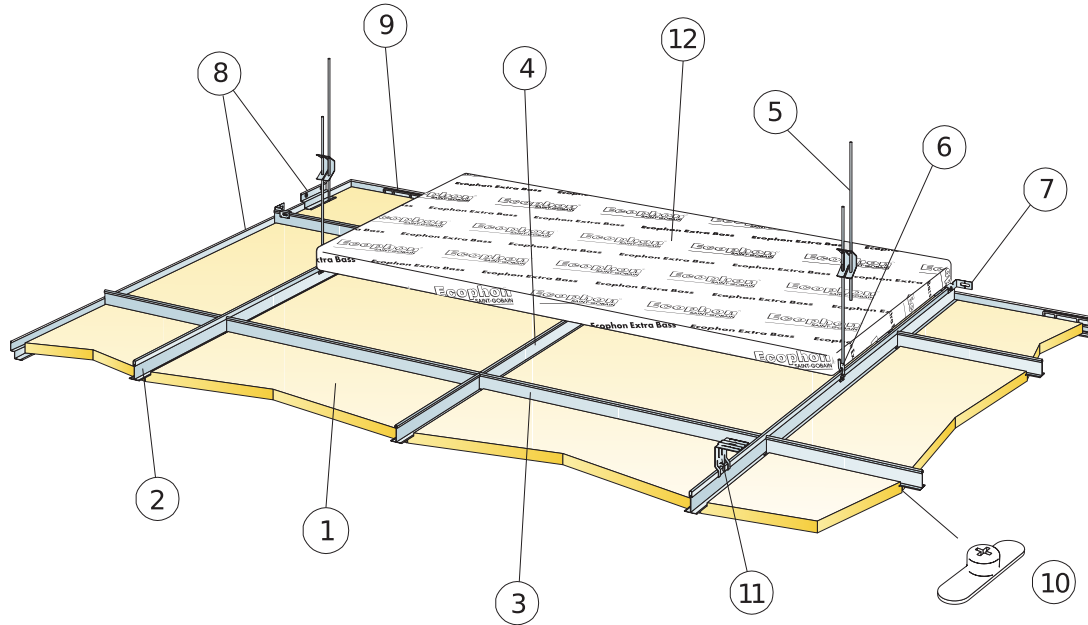

© Ecophon Group

QUANTITY SPECIFICATION (EXCL. WASTAGE)

	Size, mm	
	600x600	1200x600
1 Master Rigid Dp	2,8/m ²	1,4/m ²
2 Connect T24 Main runner, installed at 1200 mm centres (max. distance from wall 600 mm, can be extended up to 1200 mm if no live load between Main runner and wall).	0,9m/m ²	0,9m/m ²
3 Connect T24 Cross tee, L=1200 mm, installed at 600 mm centres	1,7m/m ²	1,7m/m ²
4 Connect T24 Cross tee, L=600 mm	0,9m/m ²	-
5 Connect Adjustable Hanger, installed at 1200 mm centres (max. distance from wall 600 mm)	0,7/m ²	0,7/m ²
6 Connect Hanger Clip (not to be used in swimming hall environments)	0,7/m ²	0,7/m ²
7 Connect Wall bracket for T-profiles (For every suspended row of main runner and every second row of cross tee)	as required	as required
8 Connect Shadow-line trim, fixed at 300 mm centres	as required	as required
9 Connect Wall spacer 5	1/cut tile with one bearing edge	2/cut tile with one bearing edge
10 Connect Panel lock Dp	1/panel	2/panel
11 For direct installation: Connect Direct bracket, installed at 1200 mm centres	0,7/m ²	0,7/m ²
12 Extra Bass (1200x600x50 mm)	0,7/m ²	0,7/m ²
Δ Min. overall depth of system: 115 mm	-	-
δ Min. demounting depth: 20 mm (tiles without Extra Bass above)	-	-
For luminaire integration in panels use Connect Bridging	-	-

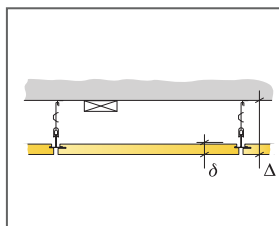

See Quantity specification

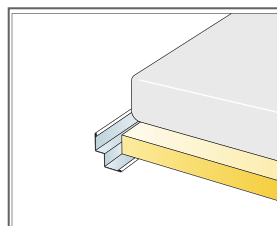

Wall connection with Connect Shadow-line trim

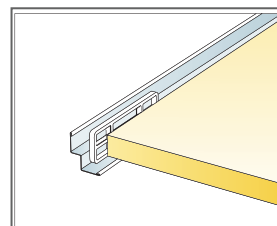

Connect Wall spacer 5 for locking of the perimeter tile

Size, mm	Max live load (N)	Min load bearing capacity (N)
600x600x20	50	160
1200x600x20	50	160

Live load/load bearing capacity

INSTALLATION DIAGRAM (M319) FOR ECOPHON MASTER RIGID DP IN CORRIDORS

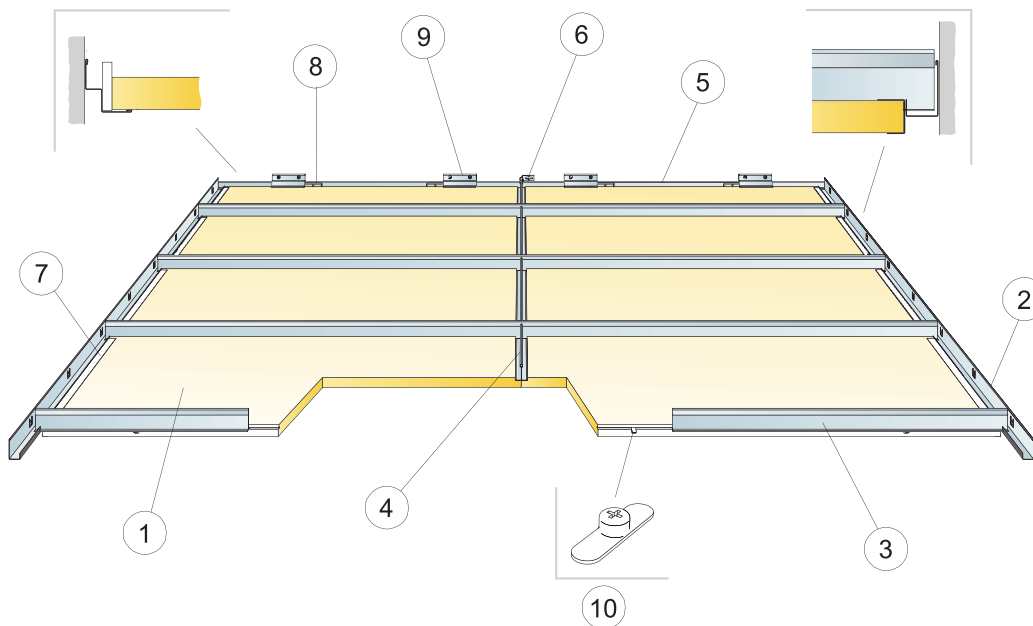

© Ecophon Group

QUANTITY SPECIFICATION (EXCL. WASTAGE)

	Size, mm	
	600x600	1200x600
1 Master Rigid Dp	2,8/m ²	1,4/m ²
2 Connect Modular Wall trim	as required	as required
3 Connect T24 Corridor profile	as required	as required
4 Connect T24 Cross tee, L=600 mm	0,9m/m ²	-
5 Connect Shadow-line trim, fixed at 300 mm centres	as required	as required
6 Connect Wall bracket for T-profiles	2 / row of cross tee	
7 Connect Cover trim Dp/Dg	as required	as required
8 Connect Wall spacer 5	1/cut tile with one bearing edge	2/cut tile with one bearing edge
9 Connect Shadow-line trim	as required	as required
10 Connect Panel lock Dp	1/panel	2/panel
Δ Min. overall depth of system: 115 mm	-	-
δ Min. demounting depth: 20 mm	-	-
For luminaire integration in panels use Connect Bridging	-	-

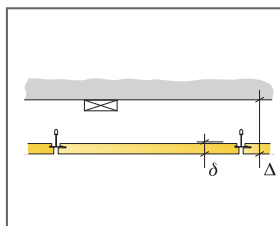

See Quantity specification

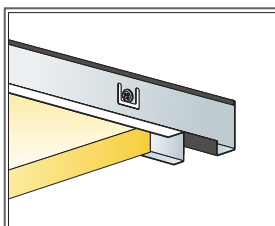

Tile and Connect Cover trim Dp/Dg

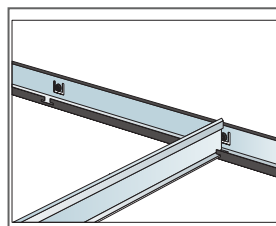

Corridor profile positioned by Modular wall trim

Size, mm	Max live load (N)	Min load bearing capacity (N)
600x600x20	0	-
1200x600x20	0	-

Live load/load bearing capacity

Ecophon Master™ Rigid E

Ecophon Master™ Rigid E has a recessed visible grid and tegular edge to create a shadow effect ceiling, accentuating each tile and partially concealing the grid system. Secured by clips, each tile is fully demountable. Together with Ecophon Extra Bass optimal acoustics are achieved.



Kubiskolan, Helsingborg, Sweden

SYSTEM RANGE

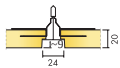

Size, mm	600x600	1200x600	1200x1200
Extra Bass	•	•	•
T24	•	•	•
Thickness (THK)	20	20	20
Inst. Diagr.	M317EB	M317EB	M317EB



Master Rigid E tile

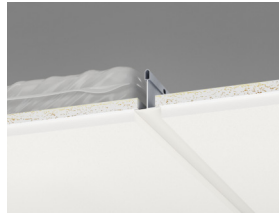

Section of Master Rigid E system with Connect T24

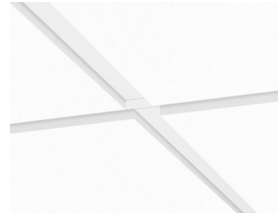

Master Rigid E system with Connect T24

Acoustic



Sound Absorption:

Test results according to EN ISO 354. Classification according to EN ISO 11654.

α_p , Practical sound absorption coefficient

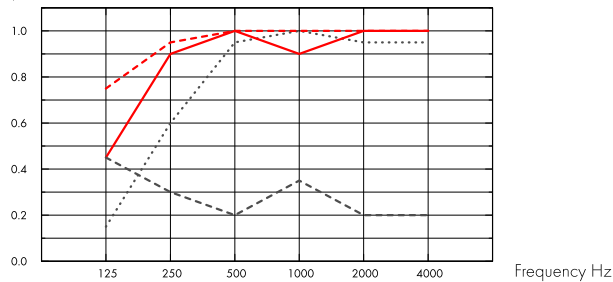

- Master Rigid E 20 mm, 60 mm o.d.s.
 - Master Rigid E 20 mm, 200 mm o.d.s.
 - - - Master Rigid E 20 mm + Extra Bass 50 mm, 200 mm o.d.s.
 - - - Master Rigid E gamma 20 mm, 200 mm o.d.s.
- o.d.s = overall depth of system

	THK mm	o.d.s. mm	α_p , Practical sound absorption coefficient					α_w	Sound absorption class
			125 Hz	250 Hz	500 Hz	1000 Hz	2000 Hz		
-	20	60	0.15	0.60	0.95	1.00	0.95	0.95	A
-	20	200	0.45	0.90	1.00	0.90	1.00	1.00	A
+ Extra Bass	70	200	0.75	0.95	1.00	1.00	1.00	1.00	A
gamma	20	200	0.45	0.30	0.20	0.35	0.20	0.20	E

Indoor Air Quality



Certificate / Label	
Eurofins Indoor Air Comfort®	IAC
French VOC	A
Finnish M1	•



Environmental Footprint



	kg CO ₂ equiv/m ²
Master Rigid E	3,27

Life-cycle stages A1 to C4 from EPD, in conformity with ISO 14025 / EN 15804



Circularity

Minimum post-consumer recycled content	45%
Recyclability	Fully recyclable



Fire safety

Country	Class
Europe	EN 13501-1 A2-s1,d0

The glass wool core of the tiles is tested and classified as non-combustible according to EN ISO 1182.



Humidity Resistance

Class C, relative humidity 95% and 30°C, according to EN 13964:2014



Visual appearance

White Frost, nearest NCS colour sample S 0500-N, 85% light reflectance. Gloss < 1.



Cleanability

Daily dusting and vacuum cleaning. Weekly wet wiping.



Accessibility

The tiles are secured in the grid, but demountable. Minimum demounting depth according to installation diagrams.



Installation

Installed according to installation diagrams, installation guides and drawing aid. For information regarding minimum overall depth of system see quantity specification.



System weight

The weight of the system (including suspension grid) should be approximately 5 kg/m².



Mechanical properties

See table regarding the min- and max- load bearing capacities and functional demands.



Impact Resistance

M-sketch

Tested and classified according to EN 13964 annex D.

M317

3A



CE

Ecophon ceiling systems are CE marked according to the European harmonized standard EN 13964:2014. CE marked construction products are covered by a Declaration of Performance (DOP) which enables customers and users to easily compare performance of products available on the European market.

INSTALLATION DIAGRAM (M317EB) FOR ECOPHON MASTER RIGID E

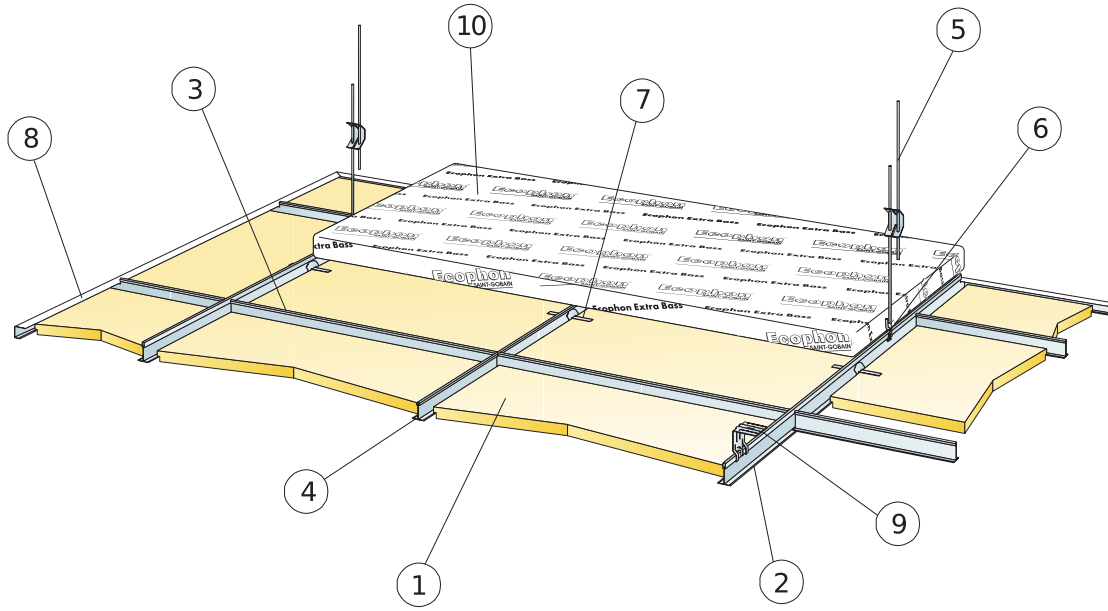

© Ecophon Group

QUANTITY SPECIFICATION (EXCL. WASTAGE)

	Size, mm		
	600x600	1200x600	1200x1200
1 Master Rigid E	2,8/m ²	1,4/m ²	0,7/m ²
2 Connect T24 Main runner, installed at 1200 mm centres (max. distance from wall 600 mm, can be extended up to 1200 mm if no live load 0,9m/m ² between Main runner and wall).	0,9m/m ²	0,9m/m ²	0,9m/m ²
3 Connect T24 Cross tee, l=1200 mm, installed at 600 mm centres	1,7m/m ²	1,7m/m ²	0,9m/m ²
4 Connect T24 Cross tee, l=600 mm	0,9m/m ²	-	-
5 Connect Adjustable Hanger, installed at 1200 mm centres (max. distance from wall 600 mm)	0,7/m ²	0,7/m ²	0,7/m ²
6 Connect Hanger Clip (not to be used in swimming hall environments)	0,7/m ²	0,7/m ²	0,7/m ²
7 Connect Hold down clip E	2pcs/panel	2pcs/panel	2pcs/panel
8 Connect Channel trim, fixed at c300 mm (1200x1200, c200 mm)	as required	as required	as required
9 For direct installation: Connect Direct bracket, installed at 1200 mm centres	0,7/m ²	0,7/m ²	0,7/m ²
10 Extra Bass (1200x600x50 mm)	0,7/m ²	0,7/m ²	0,7/m ²
11 Connect Demounting tool	-	-	-
Δ Min. overall depth of system: 110 mm	-	-	-
δ Min. demounting depth: 120 mm (tiles without Extra Bass above)	-	-	-
For luminaire integration in panels use Connect Bridging	-	-	-

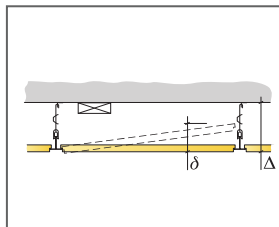

See Quantity specification

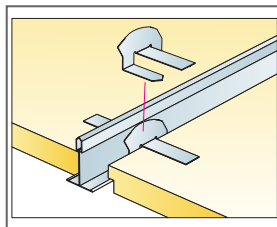

Connect Hold down clip E (patented)

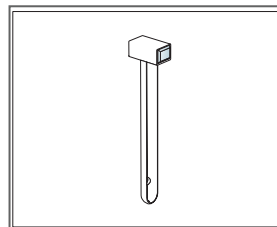

Connect Demounting tool

Size, mm	Max live load (N)	Min load bearing capacity (N)
600x600x20	50	160
1200x600x20	50	160
1200x1200x20	50	160

Live load/load bearing capacity